

# *Antologhia)*<sup>®</sup>



03/2022

## Informazioni utili per la consultazione

Useful information for the consultation

<b>KAC11 PB70</b>	<b>codice</b> code		
I 70	<b>interesse</b> centre	<b>C</b>	<b>fornitura a coppia</b> supply by pair
40  55	<b>spessore porta</b> door thickness	<b>S</b>	<b>fornitura singolo</b> supply by unit
	<b>confezione</b> package	<b>i</b>	<b>attenzione</b> important notice

## Finiture

Finishings

<b>ON</b>	<b>ottone naturale non verniciato</b> natural brass not lacquered	<b>OLV</b>	<b>ottone lucido verniciato</b> lacquered polished brass
<b>BR</b>	<b>bronzo non verniciato</b> bronze not lacquered	<b>BSV</b>	<b>bronzo satinato verniciato</b> lacquered satin bronze
<b>CR</b>	<b>cromo</b> chrome	<b>AG</b>	<b>argento naturale non verniciato</b> natural silver not lacquered
<b>NI</b>	<b>nichel naturale non verniciato</b> natural nickel not lacquered		

## Legenda

Legend

<b>P</b>	maniglia su placca con foro normale (patent), con viti in vista e molla lever on plate with key hole (patent) with exposed screws and spring
<b>PY</b>	maniglia su placca con foro cilindro (profilo euro), con viti in vista e molla lever on plate with europrofile cylinder hole with exposed screws and spring
<b>PB</b>	maniglia su placca bassa con foro normale (patent), con viti in vista e senza molla lever on flat plate with key hole (patent) with exposed screws and without spring
<b>PBY</b>	maniglia su placca bassa con foro cilindro (profilo euro), con viti in vista e senza molla lever on flat plate with europrofile cylinder hole with exposed screws and without spring
<b>PBX</b>	maniglia su placca bassa lunga con foro normale (patent), con viti in vista e senza molla lever on long flat plate with key hole (patent) with exposed screws and without spring
<b>PBXY</b>	maniglia su placca bassa lunga con foro cilindro (profilo euro), con viti in vista e senza molla lever on long flat plate with europrofile cylinder hole with exposed screws and without spring
<b>RB</b>	maniglie e/o pomolo su rosetta bassa con bocchetta bassa foro normale (patent), con viti in vista e senza molla lever and/or knob on flat rose with flat escutcheon and key hole (patent), supplied with exposed screws without spring
<b>RBV</b>	maniglie e/o pomolo su rosetta bassa con bocchetta bassa foro cilindro (profilo euro), con viti in vista e senza molla lever and/or knob on flat rose with flat escutcheon and europrofile cylinder, supplied with exposed screws without spring
<b>R</b>	maniglie e/o pomolo su rosetta con bocchetta bassa foro normale (patent) e con molla lever and/or knob on rose with escutcheon key hole (patent), supplied with spring
<b>RY</b>	maniglie e/o pomolo su rosetta con bocchetta bassa foro cilindro (profilo euro) e con molla lever and/or knob on rose with escutcheon europrofile cylinder, supplied with spring
<b>RG</b>	maniglia grande su rosetta con bocchetta bassa foro normale (patent) e con molla lever on big rose with escutcheon key hole (patent), supplied with spring
<b>RGY</b>	maniglia grande su rosetta con bocchetta bassa foro cilindro (profilo euro) e con molla lever on big rose with escutcheon europrofile cylinder, supplied with spring
<b>RBO</b>	maniglia su rosetta bassa ovale con bocchetta bassa ovale foro normale (patent), con viti in vista senza molla lever on oval flat rose with oval flat escutcheon with key hole (patent), supplied with exposed screws without spring
<b>RBOY</b>	maniglia su rosetta bassa ovale con bocchetta bassa ovale foro cilindro (profilo euro), con viti in vista senza molla lever on oval flat rose with oval flat escutcheon with europrofile cylinder, supplied with exposed screws without spring
<b>P</b>	bocchetta con foro normale (patent) senza viti a vista escutcheon with key hole (patent) and concealed screws
<b>Y</b>	bocchetta con foro cilindro (profilo euro) senza viti a vista escutcheon with europrofile cylinder hole and concealed screws
<b>BP</b>	bocchetta bassa con foro normale (patent) e viti in vista flat escutcheon with key hole (patent) and exposed screws
<b>BY</b>	bocchetta bassa con foro cilindro (profilo euro) e viti in vista flat escutcheon with europrofile cylinder hole and exposed screws
<b>BZG B</b>	nottolino interno/esterno su rosetta bassa con viti in vista e quadro 6x100mm thumbturn (internal/external side) on flat rose with exposed screws and 6x100mm spindle
<b>BZG GB</b>	nottolino interno/esterno su rosetta grande con viti in vista e quadro 6x100mm thumbturn (internal/external side) on big rose with exposed screws and 6x100mm spindle
<b>B</b>	maniglia per finestra a T placca bassa con viti in vista e quadro 7x65mm incluso T shape window handle, flat plate with exposed screws and 7x65mm spindle included
<b>2</b>	maniglia per finestra a T placca alta con viti in vista e quadro 7x70mm incluso, eventuale ulteriore movimento interno da specificare (fornito a parte) T shape window handle, high plate with exposed screws and 7x70mm spindle included, inside leverage <u>not included</u>
<b>CRDK</b>	maniglia per finestra a T su rosetta ovale DK con movimento interno da specificare (fornito a parte) T shape window handle on DK oval rose with inside leverage <u>not included</u>
<b>DK/SM</b>	maniglia per finestra (dreh-kipp) con movimento interno da specificare (fornito a parte) dreh-kipp window handle with inside leverage <u>not included</u>
<b>FISSO</b>	pomolo fisso con foro interno per barra filettata 10MA, completo di accessori per il fissaggio passante singolo e copridado interno fixed knob with internal hole for 10MA threaded bar, complete with single through fixing accessories and internal bolt

**Addizionale finiture OLV** (ottone lucido verniciato) ed **BRV** (bronzo verniciato)  
Additional finishing OLV (lacquered polished brass) and BRV (lacquered brass)

<b>MANIGLIE</b> Handles					
	<b>P</b>	<b>PB</b>	<b>PBX</b>		
<b>MANIGLIE SU PLACCA</b> HANDLES ON PLATE	<b>PY</b>	<b>PBY</b>	<b>PBXY</b>		
	<b>RB</b>	<b>R</b>	<b>RG</b>	<b>RBO</b>	
<b>MANIGLIE SU ROSETTA</b> HANDLES ON ROSE	<b>RBY</b>	<b>RY</b>	<b>RGY</b>	<b>RBOY</b>	
<b>BOCCHETTE</b> ESCUTCHEONS	<b>P</b>	<b>Y</b>	<b>BP</b>	<b>BY</b>	
<b>NOTTOLINI</b> TOILET ROSES	<b>BZG B</b>	<b>BZG GB</b>			
<b>MANIGLIE PER FINESTRA</b> HANDLE FOR WINDOWS	<b>B</b>	<b>2</b>	<b>CRDK</b>	<b>DK/SM</b>	
<b>POMOLI E POMOLINI PER MOBILE</b> Door knobs and furniture knobs					
<b>POMOLI</b> DOOR KNOBS	<b>R</b>	<b>RY</b>	<b>RB</b>	<b>RBY</b>	
<b>POMOLI FISSI</b> FIXED DOOR KNOBS	<b>FISSO</b>				
<b>POMOLINI</b> FURNITURE KNOBS					
<b>MANIGLIONI E BATTIPORTA</b> Pulls and door knockers					
<b>MANIGLIONI</b> PULLS					
<b>BATTIPORTA</b> DOOR KNOCKERS					
<b>MANIGLIE INCASSO</b> Flush handles					
<b>COMPLEMENTI</b> Complements					
<b>COPRINTERRUTTORI</b> SWITCH PLATES					
<b>CHIAVI</b> KEYS					
<b>CAMPANELLI E TARGHETTA</b> DOOR BELLS AND NAME PLATE					
<b>BUCA PER LETTERE</b> LETTER PLATE					



**Consegna in base alla disponibilità in magazzino, o in massimo 4/5 settimane**  
Delivery depending upon stock availability, or in maximum 4/5 weeks



*Colombo Design rende disponibile un servizio di personalizzazione dei prodotti della linea Antologhia. Se già la scelta del brand è un'espressione di sé, la personalizzazione di un prodotto esalta la diversità, trasformando un prodotto in un oggetto unico ed esclusivo. È una chance per il brand e il consumatore allo stesso tempo. È l'inizio di un nuovo rapporto, intimo e confidenziale, una sorta di via d'accesso preferenziale. Ma non basta, per questo motivo c'è tutto il resto: le sensazioni, il piacere e il saper raccontare e vendere emozioni.*

*Occasionali porosità o corrosioni o rugosità, che costituirebbero difetto e ragione di scarto nei comuni prodotti usciti da stampi meccanici proprio per essere identici, in oggetti di questa collezione - realizzati invece con tecniche antiche quali la fusione in terra e l'intervento della manualità - rappresentano una certificazione di autenticità e unicità. L'ossidazione nel tempo dell'ottone non verniciato forma una patina tipica degli oggetti che non hanno subito trattamenti, attestando la veridicità e l'artigianalità della collezione.*

*Data l'artigianalità dei prodotti tutti gli articoli verniciati possono presentare tracce di puntinature evidenti sulle superfici lisce.*

*Colombo Design makes available a customization service for the products of the Antologhia collection. If the choice of the brand is already an expression of oneself, the personalization of a product enhances diversity, transforming a product into a unique and exclusive object. It is a chance for the brand and for the consumer at the same time. It is the beginning of a new, intimate and confidential relationship, a sort of preferential access route. But that's not enough, for this reason there is everything else: the sensations, the pleasure and knowing how to tell and sell emotions.*

*Occasional porosity, corrosions or wrinkles in this collection, that would usually be treated as defects and therefore waste in a normal production with mechanical moulds, gives it the proper taste of the antique manufacturing process, such as the heart sand casting and the handcrafts works, awarding it with a certificate of authenticity and originality. Natural brass oxidation along the years bring about a typical patina on the object surface, which haven't been treated, awarding the authenticity and the craftwork of the collection.*

*Because of the craftsmanship of the products, all varnished treated items may show evidence of lacquer dots on flat surfaces.*

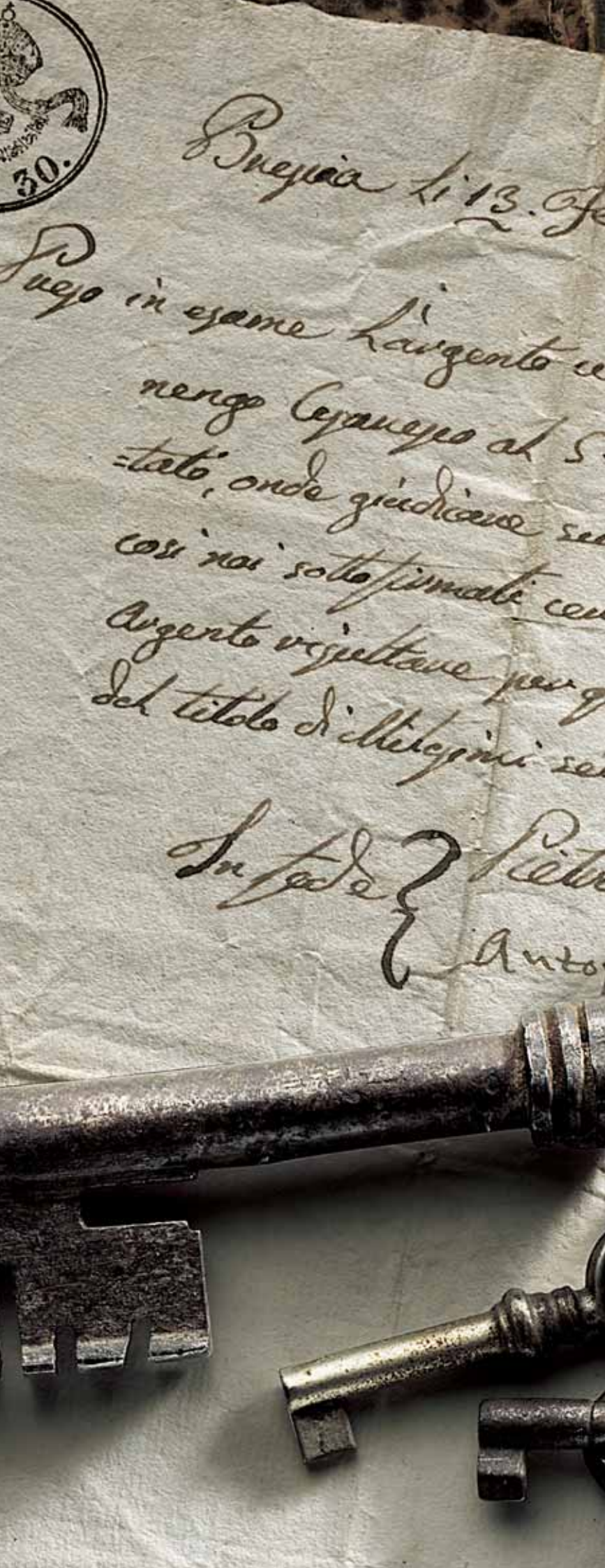

- 15 *Accademia*
- 19 *Barocco*
- 23 *Bellagio*
- 27 *Busiri*
- 31 *Byblos*
- 35 *Capri*
- 39 *Firenze*
- 43 *Impero*
- 47 *Lidia*
- 51 *Louis XVI*
- 55 *Ottocento*
- 59 *Palatino*
- 63 *Roma*
- 67 *Settecento*
- 71 *Siena*
- 75 *Venezia*
  
- 79 *Nottolini*  
*Toilet roses*
- 83 *Pomoli*  
*Door knobs*
- 93 *Maniglioni e battiporta*  
*Pulls and door knockers*
- 109 *Maniglie incasso*  
*Flush handles*
- 115 *Complementi*  
*Complements*
- 127 *Accessori*  
*Accessories*
- 131 *Espositori*  
*Display boards*
- 133 *Dati tecnici*  
*Technical datas*
- 145 *Indice dei codici*  
*Code index*

*Antologhia)*<sup>®</sup>



*Nascono da una selettiva ricerca tra i modelli del passato le nuove maniglie ora proposte dalla Colombo design. Si è puntato a ritrovare, nelle varie epoche dello stile, il valore esemplare e sempre attuale della bellezza.*

*La forma, come ha scritto un grande storico dell'arte, è precisa definizione della materia e dello spazio, "ma è anche suggestione, si estende e lievita nell'immaginario".*

*In queste nostre scelte la forma evoca e restituisce il senso di una lontana civiltà del vivere.*

*Da più di un secolo si tenta di contrastare l'impoverimento indotto dalla adozione di processi meccanizzati nella fattura degli oggetti d'uso quotidiano.*

*L'industrial design ha dato risposte a volte geniali a questa esigenza di qualità, ma sempre puntando su soluzioni coerenti con i moderni mezzi di produzione e a questi vincolate. Non ha avuto invece né la pretesa né la possibilità di rispondere alla domanda, più radicale e raffinata, di chi rimpiangeva il calore e il pregio non surrogabile che le cose avevano quando a dar loro corpo e linea era direttamente la mano dell'uomo. Anche sotto questo rispetto le maniglie della Colombo design si possono dire fasciose macchine del tempo. Costituiscono infatti molto più che un semplice ritorno a remoti modelli: e non solo perché funzionalità, profili, volumi, materiali sono stati oggetto di un'attentissima rivisitazione progettuale.*

*A caratterizzarle e a qualificarle è pure il ricupero, nella loro fabbricazione, da un lato della manualità sino in fase di rifinitura e dall'altro di tecniche quali la fusione in terra.*

*Ne consegue, tra l'altro, un istruttivo capovolgimento nei criteri stessi di valutazione: occasionali porosità o tracce di corrosione o rugosità, che costituiscono difetto e fanno scarto nei comuni prodotti usciti da stampi meccanici proprio per essere identici, ridiventano - come sempre nei manufatti - preziose aggiunte: certificazioni di autenticità e unicità, magiche e visibili carezze del caso a un'opera dell'uomo.*

*The new handles proposed now by Colombo design emerged after careful search among selective models of the past.*

*They are aimed at rediscovering, in various eras of style, the exemplary and timeless value of beauty.*

*The shape, as a great art historian wrote, is a precise definition of matter and space, "but it is also fascination, it stretches and elevates the imagination."*

*In these choices of ours, shape evokes the sense of a distant civilization of living.*

*For over a century we have been trying to counter the impoverishment caused by the adoption of mechanized processes in the manufacturing of everyday objects.*

*Industrial design has at times given brilliant answers to this need for quality, but always focusing on solutions that are consistent with and bound to these modern means of production. But it had neither the pretensions nor the opportunity to answer the question, more radical and refined, of those who missed the warmth and irreplaceable value things had when it was man's hands that gave them body and line.*

*Along these lines Colombo's handle can also be called fascinating time machines.*

*They constitute in fact much more than a simple return to ancient models.*

*Not only because functionalities, profiles, volumes, materials have undergone very careful planning study. To characterize them and qualify them is also the recovery, in their manufacture, on one side of the manual the dexterity during finishing and on the other the techniques like sand casting.*

*It follows, among other things, a reversal in educational evaluation criteria themselves: occasional signs of corrosion or porosity or wrinkles, that would usually be treated as defects and therefore waste in normal production with mechanical molds, become again - as always in products - valuable additions: certification of authenticity and uniqueness, and magical visibility caresses the case to a human work.*

	ITALIA ITALY	FRANCIA FRANCE
1400	Gotico internazionale International gothic Stile '400 italiano e inizi stile rinascimentale Italian Gothic style	Gotico internazionale fino al '500 circa International gothic until around 500 AC
1500	Pieno internazionale 1490-1550 High Renaissance 1490-1550 Tardo Rinascimento 1550-1600 Late Renaissance 1550-1600	Periodo di transizione Transition period Rinascimento 1550-1610 Renaissance 1550-1610
1600	Primo Seicento 1600-1645 Early seventeenth century 1600-1645 Seicento Barocco 1645-1675 Baroque styles of the seventeenth century 1645-1675	Luigi XIII 1610-1643 Louis XIII 1610-1643 Luigi XIV o Barocco 1643-1715 Louis XIV or Baroque 1643-1715
1700	Barocco Puro 1675-1740 Baroque 1675-1740 Barocchetto o Rococò 1740-1775 Rococo Style 1740-1775 Neo Classico 1775-1795 Neoclassicism 1775-1795	Reggenza e Rocaille 1715-1722 Regence and Rocaille 1715-1722 Luigi XV 1722-1774 Louis XV 1722-1774 Luigi XVI 1774-1792 Louis XVI 1774-1792
1800	Direttorio 1795-1805 Directoire 1795-1805 Impero 1805-1830 Empire 1805-1830 Primo Ottocento e Carlo Felice 1821-1838 Carlo Felice 1821-1838 Albertino 1831-1838 Albertino 1831-1838 Secondo Impero, Pieno Ottocento, Neo Gotico 1852-1870 Second Empire New Gothic style 1852-1870 Umbertino 1878-1900 Umbertinian style 1878-1900	Direttorio 1792-1804 Directoire 1792-1804 Impero 1804-1815 Empire 1804-1815 Restaurazione 1815-1830 Restoration and Charles 1815-1830 Luigi Filippo 1830-1848 Louis Philippe 1830-1848 Secondo Impero 1852-1870 Second Empire 1852-1870
1900	Floreale Floral style	Art Nouveau Art Nouveau

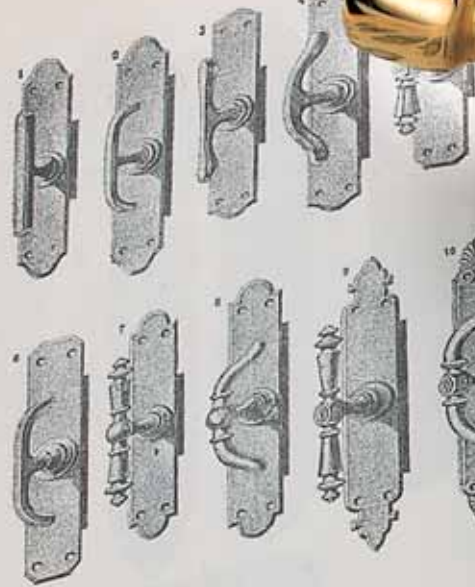

Nr.	Silber	bronze	
1	4-00	3-90	2-80
2	6-00	5-10	3-60
3	5-00	4-20	3-00
4	6-00	5-10	3-60
5	5-60	4-80	3-40
6	6-00	5-10	3-40
7	5-50	4-70	3-20
8	6-60	5-60	3-20
9	7-40	6-30	4-00
10	9-60	8-20	4-50
			5-80

Schubriegelknöpfe u. Griffe, per Stück in K:

Nr.	Silber	Rot-bronze	Messing
1	0-60	0-50	0-40
2	0-70	0-60	0-50
3	0-80	0-70	0-60
4	0-90	0-80	0-70
5	0-50	0-42	0-30
6	0-70	0-60	0-50
7	1-30	1-08	0-92
8	1-60	1-40	1-20

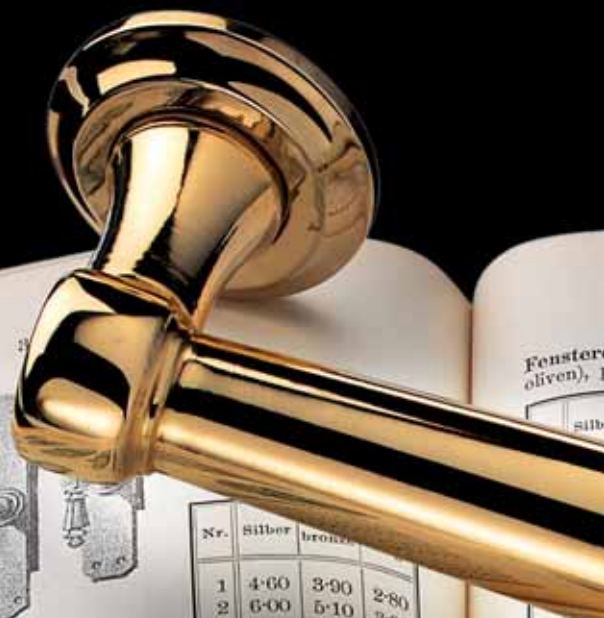
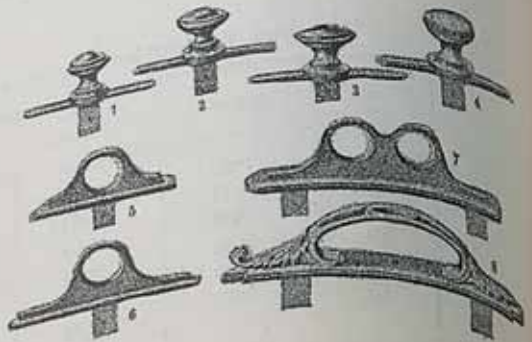

Fenster  
oliven), 1

silb

7	0-8
8	0-7
9	0-8
10	0-8
11	0-8
12	0-9
13	0-9
14	1-1
15	0-8
16	0-9
17	0-8
18	0-9
19	1-0
20	1-0
21	0-7

Fenster  
per

Nr.	silb
1	0-
2	0-
3	0-
4	0-
5	0-



Drücker (Halb-  
per Stück in K:

	Rot- bronze	Mes- sing
0	0-60	
0	0-70	0-60
0	0-70	0-60
0	0-76	0-66
6	0-84	0-70
0	0-96	0-72
0	0-70	0-60
0	0-76	0-66
0	0-70	0-60
0	0-76	0-66
0	0-84	0-76
0	0-84	0-76
0	0-60	0-50

sterdrücker-  
rosetten,  
Stück in K:

	Rot- bronze	Mes- sing
2	0-10	0-08
4	0-12	0-10
6	0-22	0-18
8	0-30	0-24
0	0-42	0-36





*Idea antica e oggi potenziata da affinatissime tecnologie, la fusione è un intervento creativo sul metallo con il concorso essenziale di due elementi primordiali: terra e fuoco.*

*Al principio di tutto c'è lo stampo, fatto di un'umida sabbia argillosa, che accoglie per pressione l'impronta dei modelli originari che si vogliono riprodurre e la fissa in due parti, un sopra e un sotto, combacianti come le valve di una conchiglia.*

*Aperto poi lo stampo e estratti i modelli, si predispose un sistema di canali in cui il metallo fuso potrà scorrere nella sabbia e raggiungere le cave forme che vi sono state definite.*

*Ora è il momento più suggestivo e dalle immagini si capisce perché un tempo si vedesse nella metallurgia l'arte di un dio chiamato Vulcano.*

*L'ottone, portato allo stato liquido in un forno ad alte temperature e prelevato con tazze di colata, viene versato nei canali dello stampo attraverso appositi pozzetti a imbuto. E' ancora incandescente.*

*Old idea, and now augmented by refined technologies, the casting is a creative intervention on the metal with the help of two essential primordial elements earth and fire.*

*At the beginning of everything there is the mold, made of damp clayey sand, that houses, by pressure, the footprint of the original models that are to be reproduced, and holds it in two parts, one above and one below, that fit together like the halves of a shell.*

*Opened the mold and then extracted the models, a system of channels is set up in which the molten metal can flow into the sand and reach the hollow shapes that have been defined.*

*It is now the most striking moment and you will understand why once the art of metallurgy was seen in a god called Vulcan.*

*Brass, led to a liquid in a furnace at high temperatures and collected with cups of casting, the mold is poured into the channels through appropriate wells funnel. It's still hot.*





*Quando l'ottone dai circa mille gradi che aveva raggiunto nel forno torna alla normale temperatura e allo stato solido, si rompe lo stampo. Con una sega - è come il taglio del cordone ombelicale - si separano dai canali di fusione i pezzi ottenuti e si passa alla loro rifinitura.*

*When the brass, from about a thousand degrees in the oven, reaches back to normal temperature and the solid state, it breaks the mold. With a saw - it's like cutting the umbilical cord - are separated by channels of the pieces obtained by casting and go to their finishing.*





*Sapiente rifinitura a mano, per la quale ci si avvale di scalpelli, frese, lucidatrici. Fino all'ultimo, è la ricerca della qualità.*

*Skillful hand finishing then follows for which we make use of chisels, cutters, polishers. Until the end, it is the pursuit of quality.*







*Maniglie*  
*Handles*

ter Farbe die Schrift.  
Da, wo man eine  
inden gewohnt war,  
ts als einen grünen  
ng, soweit von einer  
e Rede sein konnte,  
riefen. Und trotz-  
rade durch diese  
die Arbeit; sie  
hl des jungen  
tmäßig Wirt-  
lle Borzüge  
vollkommene  
iner unver-  
nung und  
nem ganz  
Seine  
lesbar-  
r Zu-  
der  
chrift  
Bei  
n-

Ernst Neumann  
**Wilh: Busch = Ausstellung**  
Künstler-  
haus  
Bellevue-  
Str. 3



Sachplakate gar nicht über-  
sehen, und für die Nüch-  
ternheit des Vorwurfs ent-  
schädigt die Freude an der  
geistvollen Wache und der  
Farbenschönheit seiner Ar-  
beiten. Zu dem Reizvoll-  
sten, was er geschaffen hat,  
sind auch seine reinen  
Schrift- und Ornament-  
plakate für die „National-  
zeitung“, den „Hannover-  
schen Anzeiger“, das Café  
Scandinavia, die Ausstel-  
lung 1913 des Deutschen  
Künstlerbundes (Abb. 96)  
u. a. zu rechnen. Figur-  
gen ihm dagegen meist  
plakate für die „National-  
zeitung“, den „Hannover-  
schen Anzeiger“, das Café  
Scandinavia, die Ausstel-  
lung 1913 des Deutschen  
Künstlerbundes (Abb. 96)  
u. a. zu rechnen.

Abb. 95. Lucian Bernhard: Ausstellungs-Plakat  
Ausgeführt von Hollerbaum & Schmidt in Berlin (Zu Seite 91)

weniger gut; er zeigt sich in ihnen zeichnerisch nicht immer der Phantastie,  
und vor allem fehlt es ihm an Beweglichkeit der Phantastie, an Fülle der Ein-  
fälle. Sehr hübsch hat er in der Anzeige einer Wilhelm Busch-Ausstellung dessen  
Fromme Helene ins Plakatmäßige überseht (Abb. 95).  
Aus der Kunstanstalt von Hollerbaum & Schmidt einmal ein Schlager unter den schon damals  
Uffische von Ernst Neumann für die berühmte Tänzerin Saharet hervor-  
gegangen. Die Zeichnung war von fabelhafter Ver-  
blüffender Kühnheit — endlich einmal ein Schlager unter den schon damals  
Und was tat die Direktion des Win-  
tergartens? Schon nach ganz kurzer  
Zeit ersetzte sie Neumanns Arbeit  
durch eine ortsche der gewöhnlichen  
Art, eine ortsche der gewöhnlichen  
Kopf der Kunst-  
breiz strahlte.  
gerade in  
theaters,  
reiche Af-  
wenig Ver-  
h Gute



Abb. 96. Lucian Bernhard: Ausstellungs-Plakat  
(Zu Seite 91)

zu  
Hollerbaum & Schmidt hinzugetreten  
sind, nenne ich H. R. Erdt, der in  
München mit ein paar zu guten Er-  
wartungen berechtigenden Arbeiten  
hervorgetreten war, gegenüber den  
Anforderungen des Berliner Groß-  
stadtplakates aber ziemlich versagt  
at, und vor allem Paul Scheurich.  
eine Blätter gehen zum großen Teile  
die Provinz; in Berlin sieht man













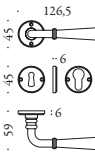

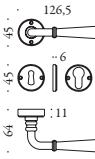

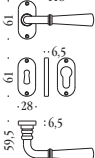

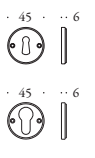
# Accademia

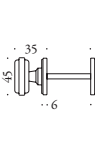
*... e un attimo dopo fu accanto alla baronessa Anna che già afferrava la maniglia della porta.  
“Perdoni! disse sottovoce, quasi che nessun altro degli astanti fosse degno di udirla. Ecco l’anello”.  
Così dicendo ficcò l’anello di Harry in mano alla baronessa; e questa tutt’ a un tratto su quella stessa mano sentì il visetto largo e acceso della ragazza.  
E una felicità, una soave, calda, arcana felicità le fece per un attimo chiudere gli occhi ...*

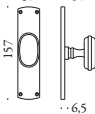
*Thomas Mann,  
Felicità (1904)*

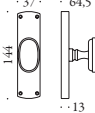
*... and a moment later he was already next to the Baroness Anna that was already grabbing the door handle.  
“Excuse me! He said softly, almost no one else of the bystanders was worthy to hear it. Here is the ring”.  
So saying, he shoved the Harry ring in hand to the baroness, and all of a sudden he felt on the same hand that little wide and flushed face of the girl.  
And a happiness, a gentle, warm, mysterious happiness made her close her eyes for a moment ...*

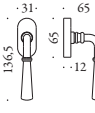
*Thomas Mann,  
Bashan and I (1904)*

<p><b>MANIGLIA SU PLACCA HANDLE ON PLATE</b></p>			<p>40 <math>\div</math> 55 8 i Senza molla Without spring</p>	<p>1 C</p>	<p>KAC11 PB70 170 KAC11 PB90 190 KAC11 PBY85 185</p>	<p>● ON ● BR ● AG</p>	
<p><b>MANIGLIA SU ROSETTA HANDLE ON ROSE</b></p>			<p>35 <math>\div</math> 50 8 i Senza molla Without spring</p>		<p>KAC11 RB 045 KAC11 RBY 045</p>	<p>● ON ● BR ● AG</p>	
			<p>35 <math>\div</math> 50 8 i Con molla With spring</p>	<p>1 C</p>	<p>KAC11 R 045 KAC11 RY 045</p>	<p>● ON ● BR ● AG</p>	
			<p>35 <math>\div</math> 50 8 i Senza molla Without spring</p>		<p>KAC11 RBO 28x61 KAC11 RBOY 28x61</p>	<p>● ON ● BR</p>	
<p><b>BOCCHETTE ESCUTCHEONS</b></p>				<p>10 S</p>	<p>KAC13 BP 045 KAC13 BY (Y) 045</p>	<p>● ON ● BR ● AG</p>	
<p><b>NOTTOLINI TOILET ROSES</b></p>			<p>35 <math>\div</math> 45 6 S</p>	<p>2 S</p>	<p>KAC19 BZG 6B 045</p>	<p>● ON ● BR ● AG</p>	
<p><b>MANIGLIA PER FINESTRA HANDLE FOR WINDOW</b></p>			<p>7 i</p>	<p>1 S</p>	<p>KAC12 B</p>	<p>● ON ● BR ● AG</p>	
			<p>Movimento non incluso Mechanism excluded</p>		<p>KAC12</p>	<p>● ON ● BR ● AG</p>	
<p><b>MANIGLIA PER FINESTRA DREH-KIPP DREH-KIPP HANDLE FOR WINDOW</b></p>			<p>i Movimento non incluso Mechanism excluded</p>	<p>1 S</p>	<p>KAC12 DK/SM</p>	<p>● ON ● BR ● AG</p>	
			<p>i Movimento non incluso Mechanism excluded</p>		<p>KAC12 CRDK</p>	<p>● ON ● BR ● AG</p>	

# Accademia



**AG** Argento naturale non verniciato  
Natural silver not lacquered



**ON** Ottone naturale non verniciato  
Natural brass not lacquered



**BR** Bronzo non verniciato  
Bronze not lacquered



**AG** Argento naturale non verniciato  
Natural silver not lacquered



**ON** Ottone naturale non verniciato  
Natural brass not lacquered



**ON** Ottone naturale non verniciato  
Natural brass not lacquered













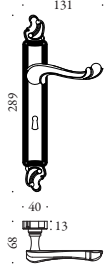







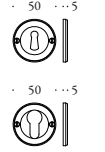



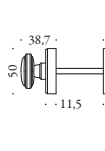

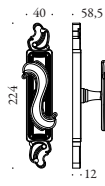

# Barocco

*... se non mostrerà le ricchissime  
spoglie, e le prede, le sarisse,  
le faretre, gli elmi, gli scudi,  
i vasi d'oro e d'argento;  
le maniglie, gli anelli,  
i guenimenti di cavallo, e gli altri  
doni militari; ...*

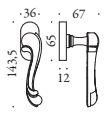
*Torquato Tasso,  
Colle Controversie sulla Gerusalemme (1823)*

*... if he won't show his glorious  
remains, his conquered catches,  
with his lances, his backpack  
containers filled with arrows, his  
shields, helmets, silver and golden  
vases; handles, rings, horse  
sufferance sounds, and all the  
war gifts; ...*

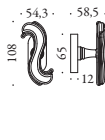
*Torquato Tasso,  
Colle Controversie sulla Gerusalemme (1823)*

<p><b>MANIGLIA SU PLACCA HANDLE ON PLATE</b></p>			<p>35 <math>\div</math> 45 8 i Con molla With spring</p>	<p>1 G</p> 	<p>KBA11 P70 I 70 KBA11 P90 I 90 KBA11 PY85 I 85</p>	<p>ON BR AG</p> 
<p><b>MANIGLIA SU ROSETTA HANDLE ON ROSE</b></p>			<p>35 <math>\div</math> 45 8 i Con molla With spring</p>	<p>1 G</p> 	<p>KBA11 R Ø50 KBA11 RY Ø50</p>	<p>ON BR AG</p> 
<p><b>BOCCHETTE ESCUTCHEONS</b></p> 				<p>10 S</p> 	<p>KBA13 P Ø50 KBA13 Y (Y) Ø50</p>	<p>ON BR AG</p> 
<p><b>NOTTOLINI TOILET ROSES</b></p> 			<p>35 <math>\div</math> 45 6</p>	<p>2 S</p> 	<p>KBA19 BZG 6G Ø50</p>	<p>ON BR AG</p> 
<p><b>MANIGLIA PER FINESTRA HANDLE FOR WINDOW</b></p>			<p>7 i Movimento non incluso Mechanism excluded</p>	<p>1 S</p> 	<p>KBA12</p>	<p>ON BR AG</p> 
<p><b>MANIGLIA PER FINESTRA DREH-KIPP DREH-KIPP HANDLE FOR WINDOW</b></p>			<p>i Movimento non incluso Mechanism excluded</p>	<p>1 S</p> 	<p>KBA12 DK/SM</p>	<p>ON BR AG</p> 
<p><b>MANIGLIA PER FINESTRA DREH-KIPP DREH-KIPP HANDLE FOR WINDOW</b></p>			<p>i Movimento non incluso Mechanism excluded</p>	<p>1 S</p> 	<p>KBA12 CRDK</p>	<p>ON BR AG</p> 



# Barocco



**ON** Ottone naturale non verniciato  
Natural brass not lacquered



**BR** Bronzo non verniciato  
Bronze not lacquered



**AG** Argento naturale non verniciato  
Natural silver not lacquered



**BR** Bronzo non verniciato  
Bronze not lacquered



**AG** Argento naturale non verniciato  
Natural silver not lacquered



**ON** Ottone naturale non verniciato  
Natural brass not lacquered



# Bellagio

*Entrarono in una sala di dove si accedeva direttamente nell'appartamento del principe Vassilij.*











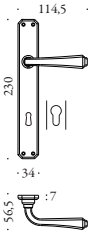

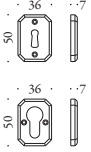

*Mentre madre e figlio, fermi in mezzo alla sala, si accingevano ad interrogare un vecchio domestico che al loro ingresso si era alzato da uno sgabello, si mosse la maniglia di bronzo di una delle porte, e il principe Vassilij in giacca di velluto da casa, con una sola decorazione, uscì, accompagnando un bell'uomo dai capelli neri. Era questi Lorrain, il famoso medico di Pietroburgo.*

*Lev Nicoàevic Tolstòj,  
Guerra e Pace (1863)*

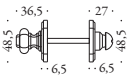
*They entered the large hall, from which one of the doors led to the apartments assigned to Prince Vasili.*

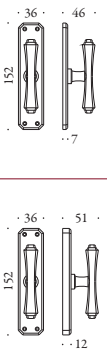
*Just as the mother and son, having reached the middle of the hall, were about to ask their way of an elderly footman who had sprung up as they entered, the bronze handle of one of the doors turned and Prince Vasili came out - wearing a velvet coat with a single star on his breast, as his custom when at home - taking leave of a good-looking, dark-haired man. This was the celebrated Petersburg doctor, Lorrain.*

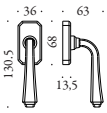
*Lev Nicoàevic Tolstòj,  
War and peace (1863)*

<p><b>MANIGLIA SU PLACCA HANDLE ON PLATE</b></p>			<p>40 ÷ 48 8 i Senza molla Without spring</p>		<p><b>KBE11 PB70 170 KBE11 PB90 190 KBE11 PBY85 185</b></p>	<p>● ON ● BR</p>
<p><b>MANIGLIA SU ROSETTA HANDLE ON ROSE</b></p>			<p>40 ÷ 48 8 i Senza molla Without spring</p>		<p><b>KBE11 RB 36x50 KBE11 RBY 36x50</b></p>	<p>● ON ● BR ● CR</p>
<p><b>BOCCHETTE ESCUTCHEONS</b></p>					<p><b>KBE13 BP 36x50 KBE13 BY (Y) 36x50</b></p>	<p>● ON ● BR ● CR</p>
<p><b>NOTTOLINI TOILET ROSES</b></p>			<p>35 ÷ 45 6</p>		<p><b>KBU19 BZG 6B 36,5x48,5</b></p>	<p>● ON ● BR ● CR</p>
<p><b>MANIGLIA PER FINESTRA HANDLE FOR WINDOW</b></p>			<p>7 i Movimento non incluso Mechanism excluded</p>		<p><b>KBE12 B</b></p> <p><b>KBE12</b></p>	<p>● ON ● BR ● CR</p> <p>● ON ● BR ● CR</p>
<p><b>MANIGLIA PER FINESTRA DREH-KIPP DREH-KIPP HANDLE FOR WINDOW</b></p>			<p>i Movimento non incluso Mechanism excluded</p>		<p><b>KBE12 DK/SM</b></p>	<p>● ON ● BR ● CR</p>



**ON** Ottone naturale non verniciato  
Natural brass not lacquered



**BR** Bronzo non verniciato  
Bronze not lacquered



**CR** Cromo  
Chrome

**ON** Ottone naturale non verniciato  
Natural brass not lacquered

**BR** Ottone non verniciato  
Bronze not lacquered

**CR** Cromo  
Chrome















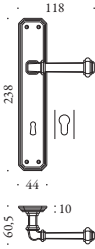

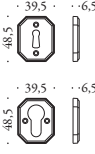

# Busiri

*"Grazie, lui mi conosce",  
disse Scrooge, che aveva già la  
mano sulla maniglia della sala  
da pranzo. "Entrerò qui, mia cara."  
Fece girare la maniglia pian piano,  
e si affacciò alla porta semiaperta.  
Stavano guardando la tavola  
apparecchiata con un gran lusso,  
perché i padroni di casa, quando  
sono giovani, sono sempre nervosi  
su questo punto e vogliono esser  
sicuri che tutto sia in perfetto  
ordine.*

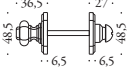
*Charles Dickens,  
Un canto di natale (1843)*

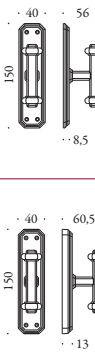
*"Thank'ee. He knows me",  
said Scrooge, with his hand  
already on the dining-room lock.  
"I'll go in here, my dear."  
He turned the handle gently, and  
sidled his face in, round the door.  
They were looking at the table  
(which was spread out in great  
array); for these young  
housekeepers are always nervous  
on such points, and like to see that  
everything is right.*

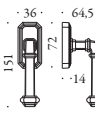
*Charles Dickens,  
A Christmas Carol (1843)*

<p><b>MANIGLIA SU PLACCA HANDLE ON PLATE</b></p>			<p>35 <math>\div</math> 48 8 Con molla With spring</p>		<p><b>KBU11 P70</b> 170 <b>KBU11 P90</b> 190 <b>KBU11 PY85</b> 185</p>	<p>● ON ● BR ● AG ● CR</p>	
<p><b>MANIGLIA SU ROSETTA HANDLE ON ROSE</b></p>			<p>40 <math>\div</math> 53 8 Con molla With spring</p>		<p><b>KBU11 R</b> 39,5x48,5 <b>KBU11 RY</b> 39,5x48,5</p>	<p>● ON ● BR ● AG ● CR</p>	
<p><b>BOCCHETTE ESCUTCHEONS</b></p>					<p><b>KBU13 BP</b> 39,5x48,5 <b>KBU13 BY (Y)</b> 39,5x48,5</p>	<p>● ON ● BR ● AG ● CR</p>	
<p><b>NOTTOLINI TOILET ROSES</b></p>			<p>35 <math>\div</math> 45 6</p>		<p><b>KBU19 BZG 6B</b> 36,5x48,5</p>	<p>● ON ● BR ● AG ● CR</p>	
<p><b>MANIGLIA PER FINESTRA HANDLE FOR WINDOW</b></p>			<p>7 Movimento non incluso Mechanism excluded</p>		<p><b>KBU12 B</b></p> <p><b>KBU12</b></p>	<p>● ON ● BR ● AG</p> <p>● ON ● BR ● AG</p>	
<p><b>MANIGLIA PER FINESTRA DREH-KIPP DREH-KIPP HANDLE FOR WINDOW</b></p>			<p>Movimento non incluso Mechanism excluded</p>		<p><b>KBU12 DK/SM</b></p>	<p>● ON ● BR ● AG ● CR</p>	





**ON** Ottone naturale non verniciato  
Natural brass not lacquered



**BR** Bronzo non verniciato  
Bronze not lacquered



**AG** Argento naturale non verniciato  
Natural silver not lacquered



**CR** Cromo  
Chrome

**ON** Ottone naturale non verniciato  
Natural brass not lacquered

**AG** Argento naturale non verniciato  
Natural silver not lacquered





# Byblos

*“È una donna”, lo fermò, le dita  
aggrappate alla maniglia, gli occhi  
spalancati.*











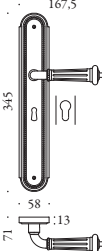



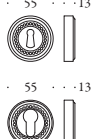

*Egli sentiva tutto il suo antico  
animo filiale ribellarsi in quella  
immobilità e tirarlo indietro;  
ma quello nuovo, ancora timido,  
eppure già forte, lo costringeva a  
fissare spietatamente  
gli occhi riluttanti là dove il giorno  
prima non avrebbe osato levarli.*

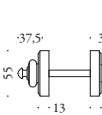
*Alberto Moravia,  
Agostino (1944)*

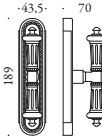
*“Is a woman”, he stopped him,  
fingers gripping the handle,  
eyes wide.*

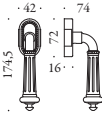
*He felt all his former rebel in the  
soul of a child still coming back;  
but the new one, still shy, but  
already strong, forcing him to fix  
his eyes fiercely reluctant to where  
the day before would not have  
dared to remove them.*

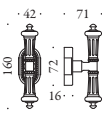
*Alberto Moravia,  
Agostino (1944)*

<p><b>MANIGLIA SU PLACCA HANDLE ON PLATE</b></p>			<p>30 ÷ 45 8 i Con molla With spring</p>		<p><b>KBY11 P70 I 70 KBY11 P90 I 90 KBY11 PY85 I 85</b></p>	<p>● OLV ● BSV</p>
<p><b>MANIGLIA SU ROSETTA HANDLE ON ROSE</b></p>			<p>30 ÷ 45 8 i Con molla With spring</p>		<p><b>KBY11 R Ø55 KBY11 RY Ø55</b></p>	<p>● OLV ● BSV</p>
<p><b>BOCCHETTE ESCUTCHEONS</b></p>			<p>10 S</p>		<p><b>KBY13 P Ø55 KBY13 Y (Y) Ø55</b></p>	<p>● OLV ● BSV</p>
<p><b>NOTTOLINI TOILET ROSES</b></p>			<p>40 ÷ 50 6</p>		<p><b>KBY19 BZG 6B Ø55</b></p>	<p>● OLV ● BSV</p>
<p><b>MANIGLIA PER FINESTRA HANDLE FOR WINDOW</b></p>			<p>7 i Movimento non incluso Mechanism excluded</p>		<p><b>KBY12</b></p>	<p>● OLV ● BSV</p>
<p><b>MANIGLIA PER FINESTRA DREH-KIPP HANDLE FOR WINDOW</b></p>			<p>i Movimento non incluso Mechanism excluded</p>		<p><b>KBY12 DK/SM</b></p>	<p>● OLV ● BSV</p>
<p><b>MANIGLIA PER FINESTRA DREH-KIPP HANDLE FOR WINDOW</b></p>			<p>i Movimento non incluso Mechanism excluded</p>		<p><b>KBY12 CRDK</b></p>	<p>● OLV ● BSV</p>



**OLV** Ottone lucido verniciato  
Lacquered polished brass



**BSV** Bronzo satinato verniciato  
Lacquered satin bronze



**OLV** Ottone lucido verniciato  
Lacquered polished brass



**OLV** Ottone lucido verniciato  
Lacquered polished brass



**OLV** Ottone lucido verniciato  
Lacquered polished brass



ÉTÉ  
LA  
AGNE

CAPRI.

PICTURE IN THE ROYAL COLLECTION

LONDON, PUBLISHED FOR THE PROPRIETORS













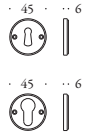

# Capri

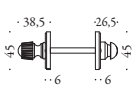
*Lo ripose quasi con dispiacere fra  
le pagine, chiuse il libro e lo  
ricollocò sullo sgabello.  
Era tempo: la maniglia della porta  
girò ed un uomo si fece innanzi,  
camminando lentamente e con  
quella rigidezza che è particolare  
agli uomini di razza anglosassone.*

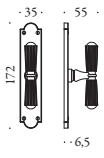
*Emilio Salgari,  
Le tigri di Mompracen (1900)*

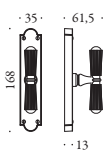
*He put it back with displeasure  
between the pages, he closed the book  
and he relocated it on the stool.  
It was time: the door handle turned  
and a man came forward, walking  
slowly and with a stiffness that is  
typical of the men of the  
Anglo-Saxon race.*

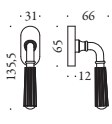
*Emilio Salgari,  
Le tigri di Mompracen (1900)*

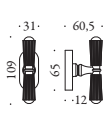
<p><b>MANIGLIA SU ROSETTA HANDLE ON ROSE</b></p>			<p>35 <math>\pm</math> 50 8 i Senza molla Without spring</p>	 C	<p>KCR11 RB Ø45 KCR11 RBY Ø45</p>	<p>● ON ● BR</p>	
<p><b>BOCCHETTE ESCUTCHEONS</b></p>				 S	<p>KAC13 BP Ø45 KAC13 BY (Y) Ø45</p>	<p>● ON ● BR</p>	
<p><b>NOTTOLINI TOILET ROSES</b></p>			<p>35 <math>\pm</math> 45 6</p>	 S	<p>KCR19 BZG 6B Ø45</p>	<p>● ON ● BR</p>	
<p><b>MANIGLIA PER FINESTRA HANDLE FOR WINDOW</b></p>			<p>7 i Movimento non incluso Mechanism excluded</p>	 S	<p>KCR12 B</p>	<p>● ON ● BR</p>	
					<p>KCR12</p>	<p>● ON ● BR</p>	
<p><b>MANIGLIA PER FINESTRA DREH-KIPP DREH-KIPP HANDLE FOR WINDOW</b></p>			<p>i Movimento non incluso Mechanism excluded</p>	 S	<p>KCR12 DK/SM</p>	<p>● ON ● BR</p>	
			<p>i Movimento non incluso Mechanism excluded</p>		<p>KCR12 CRDK</p>	<p>● ON ● BR</p>	





**BR** Bronzo non verniciato  
Bronze not lacquered



**ON** Ottone naturale non verniciato  
Natural brass not lacquered

**ON** Ottone naturale non verniciato  
Natural brass not lacquered

**ON** Ottone naturale non verniciato  
Natural brass not lacquered

**BR** Bronzo non verniciato  
Bronze not lacquered



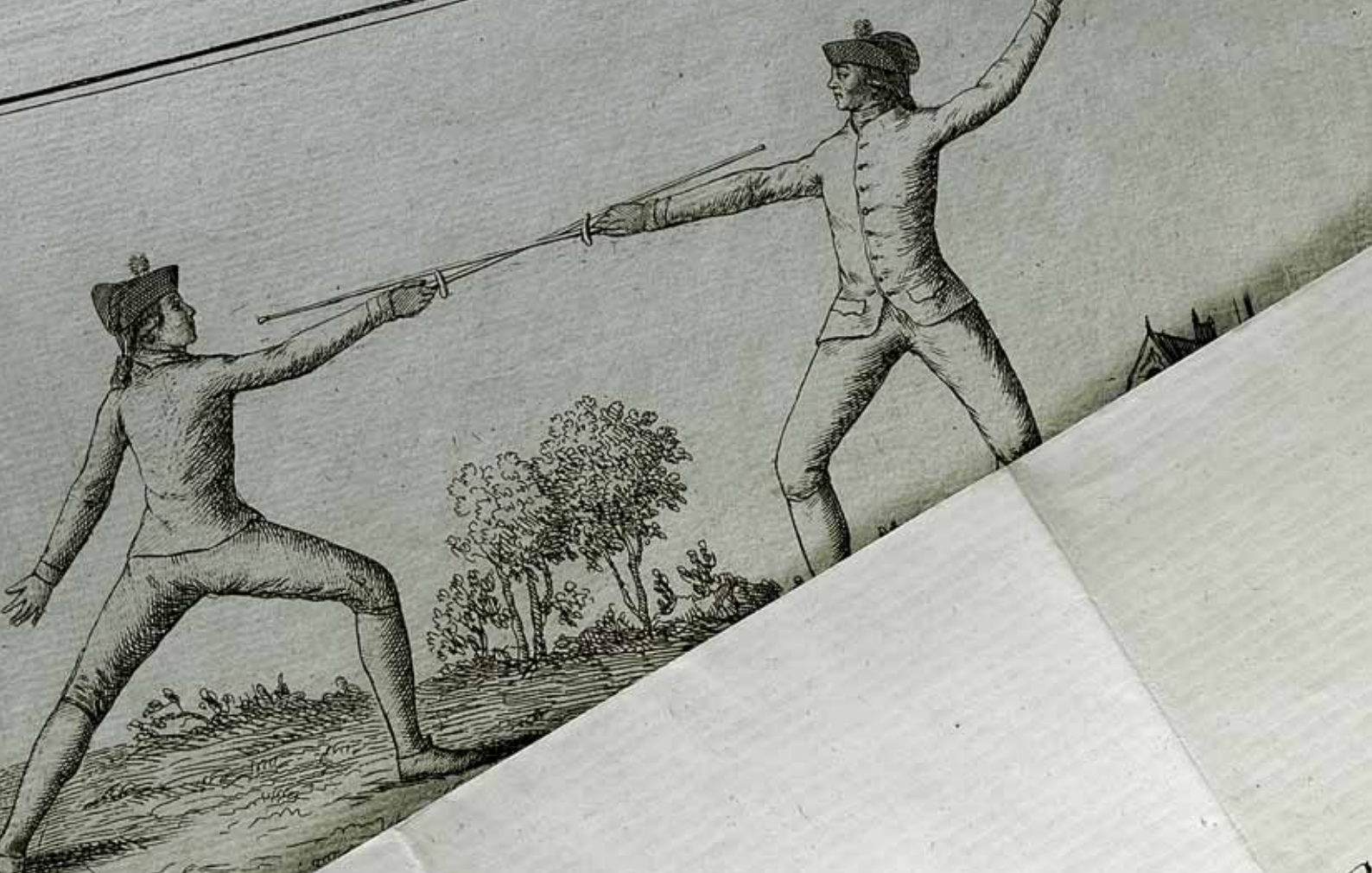

Consolati di Heiligenbrunn e Po  
Cavaliere dell' I. R. Ordine Austro  
Consolati nata Barone  
Ferdinando Conte de Konsolati, Dottore  
Bianca Contessa de Thun-Hohe  
Dobaldo de Thun-Hohe  
I. R. Apost., Car. de  
Bran Cacciatore  
idi, M

# Firenze

*Era una specie di iniziazione alla vita, l'accesso ai piaceri proibiti; entrando posava la mano sulla maniglia della porta con un piacere quasi sensuale.*











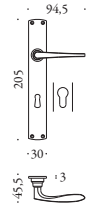

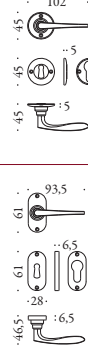



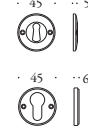

*E allora molti lati nascosti del suo carattere si rivelarono: imparò canzonacce che cantava durante le bevute, si entusiasmò per Béranger, imparò a prepararsi il ponce e infine conobbe l'amore.*

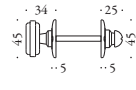
*Gustave Flaubert,  
Madame Bovary (1856)*

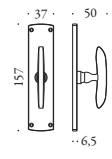
*It was beginning to see life, the sweetness of stolen pleasures; and when he entered, he put his hand on the door-handle with a joy almost sensual.*

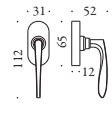
*Then many things hidden within him came out; he learnt couplets by heart and sang them to his boon companions, became enthusiastic about Beranger, learnt how to make punch, and finally, how to make love.*

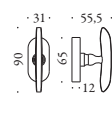
*Gustave Flaubert,  
Madame Bovary (1856)*

<p><b>MANIGLIA SU PLACCA HANDLE ON PLATE</b></p>			<p>48 <math>\div</math> 55 8 i Senza molla Without spring</p>		<p><b>KOT21 PB70 170 KOT21 PB90 190 KOT21 PBY85 185</b></p>	<p>● ON ● BR</p>	
<p><b>MANIGLIA SU ROSETTA HANDLE ON ROSE</b></p>			<p>42 <math>\div</math> 55 8 i Senza molla Without spring</p>		<p><b>KOT21 RB Ø45 KOT21 RBY Ø45</b></p>	<p>● ON ● BR ● NI</p>	
<p><b>BOCCHETTE ESCUTCHEONS</b></p> 					<p><b>KOT13 BP Ø45 KOT13 BY (Y) Ø45</b></p>	<p>● ON ● BR ● NI</p>	
<p><b>NOTTOLINI TOILET ROSES</b></p> 			<p>35 <math>\div</math> 45 6</p>		<p><b>KOT19 BZG 6B Ø45</b></p>	<p>● ON ● BR ● NI</p>	
<p><b>MANIGLIA PER FINESTRA HANDLE FOR WINDOW</b></p>			<p>7 i Movimento non incluso Mechanism excluded</p>		<p><b>KOT22 B</b></p>	<p>● ON ● BR ● NI</p>	
<p><b>MANIGLIA PER FINESTRA DREH-KIPP DREH-KIPP HANDLE FOR WINDOW</b></p>			<p>i Movimento non incluso Mechanism excluded</p>		<p><b>KOT22 DK/SM</b></p>	<p>● ON ● BR ● NI</p>	
<p><b>MANIGLIA PER FINESTRA DREH-KIPP DREH-KIPP HANDLE FOR WINDOW</b></p>			<p>i Movimento non incluso Mechanism excluded</p>		<p><b>KOT22 CRDK</b></p>	<p>● ON ● BR ● NI</p>	



**ON** Ottone naturale non verniciato  
Natural brass not lacquered



**BR** Bronzo non verniciato  
Bronze not lacquered



**NI** Nichel naturale non verniciato  
Natural nickel not lacquered

**ON** Ottone naturale non verniciato  
Natural brass not lacquered

**NI** Nichel naturale non verniciato  
Natural nickel not lacquered



**ON** Ottone naturale non verniciato  
Natural brass not lacquered















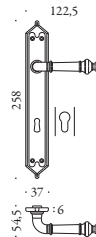





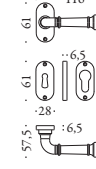

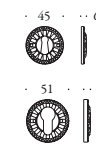
# Impero

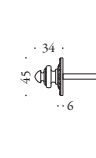
*Si udì la sua mano tentar un uscio,  
girar una maniglia.  
Una lama di luce brillò nel  
corridoio ... Entrarono.  
V'erano candele accese sulla  
ribalta calata dello stipò, sul piano  
aperto, sopra una libreria bassa.  
Dalla porta spalancata della  
camera da letto entrava pure un  
debole chiarore.  
Grandi mazzi sciolti di glicine  
celesti, di rose bianche e gialle  
erano sparsi un po' dappertutto ...*

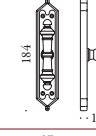
*Antonio Fogazzaro,  
Malombra (1881)*

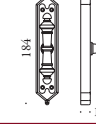
*You heard his hand groped a door,  
turn a handle.  
A sliver of light shone in the hall. . .  
They entered.  
There were candles lit on stage on  
open cabinet over a low bookcase.  
From the open door of the bedroom  
came a faint glow as well.  
Large loose clusters of wisteria blue,  
yellow and white roses were scattered  
almost everywhere ...*

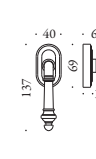
*Antonio Fogazzaro,  
The Woman (1881)*

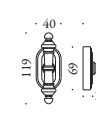
<p><b>MANIGLIA SU PLACCA</b> HANDLE ON PLATE</p>			<p>35 <math>\div</math> 45 8 i Senza molla Without spring</p>	<p>1 C</p>	<p>KIM11 PB70 I 70 KIM11 PB90 I 90 KIM11 PBY85 I 85</p>	<p>ON BR AG</p>	
<p><b>MANIGLIA SU ROSETTA</b> HANDLE ON ROSE</p>			<p>41 <math>\div</math> 51 8 i Senza molla Without spring</p>		<p>KIM11 RB Ø45 KIM11 RBY Ø50</p>	<p>ON BR AG</p>	
			<p>38 <math>\div</math> 48 8 i Con molla With spring</p>	<p>1 C</p>	<p>KIM11 R Ø45 KIM11 RY Ø50</p>	<p>ON BR AG</p>	<p>i Versione con dimensioni maggiorate disponibile su richiesta Version with increased dimensions available on request</p>
			<p>40 <math>\div</math> 50 8 i Senza molla Without spring</p>		<p>KIM11 RBO 28x61 KIM11 RBOY 28x61</p>	<p>ON BR AG</p>	
<p><b>BOCCHETTE ESCUTCHEONS</b></p>				<p>10 S</p>	<p>KLU13 BP Ø45 KLU13 BY (Y) Ø50</p>	<p>ON BR AG</p>	
<p><b>NOTTOLINI TOILET ROSES</b></p>			<p>35 <math>\div</math> 45 6 S</p>	<p>2 S</p>	<p>KIM19 BZG 6B Ø45</p>	<p>ON BR AG</p>	<p>i Versione con rosetta maggiorata (Ø52) disponibile su richiesta Version with increased rose (Ø52) available on request</p>
<p><b>MANIGLIA PER FINESTRA</b> HANDLE FOR WINDOW</p>			<p>7 i</p>	<p>1 S</p>	<p>KIM12 B</p>	<p>ON BR AG</p>	
			<p>Movimento non incluso Mechanism excluded</p>		<p>KIM12</p>	<p>ON BR AG</p>	
<p><b>MANIGLIA PER FINESTRA DREH-KIPP</b> DREH-KIPP HANDLE FOR WINDOW</p>			<p>i Movimento non incluso Mechanism excluded</p>	<p>1 S</p>	<p>KIM12 DK/SM</p>	<p>ON BR AG</p>	
			<p>i Movimento non incluso Mechanism excluded</p>		<p>KIM12 CRDK</p>	<p>ON BR AG</p>	





**ON** Ottone naturale non verniciato  
Natural brass not lacquered



**BR** Bronzo non verniciato  
Bronze not lacquered



**AG** Argento naturale non verniciato  
Natural silver not lacquered

**ON** Ottone naturale non verniciato  
Natural brass not lacquered

**AG** Argento naturale non verniciato  
Natural silver not lacquered



**ON** Ottone naturale non verniciato  
Natural brass not lacquered





MARIE-ANTOINETTE  
REINE DE FRANCE  
ET DE NAVARRE

LETTRES  
CHOISIES  
DE M<sup>MES</sup> DE SÉVIGNE,  
DE GRIGNAN, DE SIMIANE,  
ET DE MAINTENON;

avec des RÉFLEXIONS de M. l'Abbé DE  
MONTIGNY, et accompagnées des NOTES  
de M. GROUVELLE.

TOME PREMIER.

PARIS  
BOSSANGE et MASSON, Imp.-Lib., rue de Tournon, n° 6.  
1817.













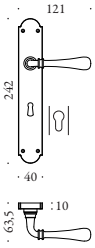

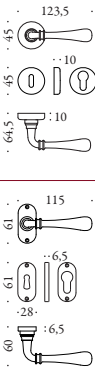

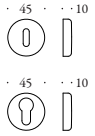

# Lidia

*Stava là sulla soglia, stupito,  
con una mano sulla maniglia della  
porta socchiusa, con la testa un po'  
china innanzi e oscillante,  
col corpo avvolto in una veste da  
camera bianca diritta e senza  
pieghe come un ...*

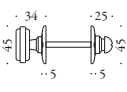
*Victor Hugo,  
I miserabili (1862)*

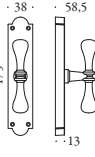
*She stood astonished on the  
threshold, one hand on the handle  
of the half- open door, with his head  
bent a little forward and quivering,  
his body wrapped in a white  
dressing-gown, which was straight  
and as destitute of ...*

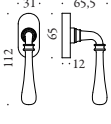
*Victor Hugo,  
Les Misérables (1862)*

<p><b>MANIGLIA SU PLACCA HANDLE ON PLATE</b></p>			<p>40 <math>\div</math> 48 8 i Con molla With spring</p>		<p><b>KOT31 P70 170 KOT31 P90 190 KOT31 PY85 185</b></p>	<p>ON BR CR</p>	
<p><b>MANIGLIA SU ROSETTA HANDLE ON ROSE</b></p>			<p>42 <math>\div</math> 55 8 i Con molla With spring</p>		<p><b>KOT31 R 045 KOT31 RY 045</b></p>	<p>ON BR CR</p>	
<p><b>BOCCHETTE ESCUTCHEONS</b></p> 					<p><b>KOT23 P 045 KOT23 Y (Y) 045</b></p>	<p>ON BR CR</p>	
<p><b>NOTTOLINI TOILET ROSES</b></p> 			<p>35 <math>\div</math> 45 6</p>		<p><b>KOT19 BZG 6B 045</b></p>	<p>ON BR CR</p>	
<p><b>MANIGLIA PER FINESTRA HANDLE FOR WINDOW</b></p>			<p>7 i Movimento non incluso Mechanism excluded</p>		<p><b>KOT32</b></p>	<p>ON BR CR</p>	
<p><b>MANIGLIA PER FINESTRA DREH-KIPP DREH-KIPP HANDLE FOR WINDOW</b></p>			<p>i Movimento non incluso Mechanism excluded</p>		<p><b>KOT32 DK/SM</b></p>	<p>ON BR CR</p>	



**ON** Ottone naturale non verniciato  
Natural brass not lacquered



**BR** Bronzo non verniciato  
Bronze not lacquered



**CR** Cromo  
Chrome

**CR** Cromo  
Chrome



**BR** Ottone non verniciato  
Bronze not lacquered



# PIANTA DELLA CITTÀ DI MILANO

publicata nell'anno 1827. ✨ incisa da Giuseppe Serze.

## DICHIARAZIONE

In questa Pianta sono distinte con tinte variate le Giurisdizioni delle ventiquattro Parrocchie componenti la Città, essendo particolarmente indicate le Chiese Parrocchiali le Chiese Subsidiarie cogli Oratorj e le Chiese Pubbliche di Forte Le Chiese Subsidiarie cogli Oratorj aperti al Pubblico. Le Chiese Subsidiarie con tinta acquarella e la medesima tinta si è ivi tenuta alquanto più risentita, e la stessa pratt servata nei Stabilimenti pubblici. Circondarij di Polizia, nei quali sono indicati i perimetri dei quattro Circondarij di Polizia, come pure Città, i quali Circondarij sono altresì distinti coi numeri progressivi romani. In tutte le Contrade e Vicoli si è scritto il nome rispettivo, come pure indicati i corrispondenti numeri civici. Stabilimenti pubblici, come pure Sono distinti ed indicati tutti gli Stabilimenti utili la Pianta, si è bena con diverse importanti notizie Statistiche.

Si trova vendibile presso l'Incisore al Ponte di Porta Orientale



Divisione della Città (colore)	Numero del Circondario	Oratorj = Stato Civico del 1826 = Campi Santi =	Oratorj Subsidiarij
Parrocchia di S. Antonio	1791	I	
Parrocchia di S. Marco	1792	II	
Parrocchia di S. Andrea	1793	III	
Parrocchia di S. Maria	1794	IV	
Parrocchia di S. Rocco	1795		
Parrocchia di S. Felice	1796		
Parrocchia di S. Spirito	1797		
Parrocchia di S. Gerolamo	1798		
Parrocchia di S. Barnaba	1799		
Parrocchia di S. Vito	1800		
Parrocchia di S. Carlo	1801		
Parrocchia di S. Ambrogio	1802		
Parrocchia di S. Siro	1803		
Parrocchia di S. Eusebio	1804		
Parrocchia di S. Felice	1805		
Parrocchia di S. Spirito	1806		
Parrocchia di S. Gerolamo	1807		
Parrocchia di S. Barnaba	1808		
Parrocchia di S. Vito	1809		
Parrocchia di S. Carlo	1810		
Parrocchia di S. Ambrogio	1811		
Parrocchia di S. Siro	1812		
Parrocchia di S. Eusebio	1813		
Parrocchia di S. Felice	1814		
Parrocchia di S. Spirito	1815		
Parrocchia di S. Gerolamo	1816		
Parrocchia di S. Barnaba	1817		
Parrocchia di S. Vito	1818		
Parrocchia di S. Carlo	1819		
Parrocchia di S. Ambrogio	1820		
Parrocchia di S. Siro	1821		
Parrocchia di S. Eusebio	1822		
Parrocchia di S. Felice	1823		
Parrocchia di S. Spirito	1824		
Parrocchia di S. Gerolamo	1825		
Parrocchia di S. Barnaba	1826		
Parrocchia di S. Vito	1827		
Parrocchia di S. Carlo	1828		
Parrocchia di S. Ambrogio	1829		
Parrocchia di S. Siro	1830		
Parrocchia di S. Eusebio	1831		
Parrocchia di S. Felice	1832		
Parrocchia di S. Spirito	1833		
Parrocchia di S. Gerolamo	1834		
Parrocchia di S. Barnaba	1835		
Parrocchia di S. Vito	1836		
Parrocchia di S. Carlo	1837		
Parrocchia di S. Ambrogio	1838		
Parrocchia di S. Siro	1839		
Parrocchia di S. Eusebio	1840		
Parrocchia di S. Felice	1841		
Parrocchia di S. Spirito	1842		
Parrocchia di S. Gerolamo	1843		
Parrocchia di S. Barnaba	1844		
Parrocchia di S. Vito	1845		
Parrocchia di S. Carlo	1846		
Parrocchia di S. Ambrogio	1847		
Parrocchia di S. Siro	1848		
Parrocchia di S. Eusebio	1849		
Parrocchia di S. Felice	1850		
Parrocchia di S. Spirito	1851		
Parrocchia di S. Gerolamo	1852		
Parrocchia di S. Barnaba	1853		
Parrocchia di S. Vito	1854		
Parrocchia di S. Carlo	1855		
Parrocchia di S. Ambrogio	1856		
Parrocchia di S. Siro	1857		
Parrocchia di S. Eusebio	1858		
Parrocchia di S. Felice	1859		
Parrocchia di S. Spirito	1860		
Parrocchia di S. Gerolamo	1861		
Parrocchia di S. Barnaba	1862		
Parrocchia di S. Vito	1863		
Parrocchia di S. Carlo	1864		
Parrocchia di S. Ambrogio	1865		
Parrocchia di S. Siro	1866		
Parrocchia di S. Eusebio	1867		
Parrocchia di S. Felice	1868		
Parrocchia di S. Spirito	1869		
Parrocchia di S. Gerolamo	1870		
Parrocchia di S. Barnaba	1871		
Parrocchia di S. Vito	1872		
Parrocchia di S. Carlo	1873		
Parrocchia di S. Ambrogio	1874		
Parrocchia di S. Siro	1875		
Parrocchia di S. Eusebio	1876		
Parrocchia di S. Felice	1877		
Parrocchia di S. Spirito	1878		
Parrocchia di S. Gerolamo	1879		
Parrocchia di S. Barnaba	1880		
Parrocchia di S. Vito	1881		
Parrocchia di S. Carlo	1882		
Parrocchia di S. Ambrogio	1883		
Parrocchia di S. Siro	1884		
Parrocchia di S. Eusebio	1885		
Parrocchia di S. Felice	1886		
Parrocchia di S. Spirito	1887		
Parrocchia di S. Gerolamo	1888		
Parrocchia di S. Barnaba	1889		
Parrocchia di S. Vito	1890		
Parrocchia di S. Carlo	1891		
Parrocchia di S. Ambrogio	1892		
Parrocchia di S. Siro	1893		
Parrocchia di S. Eusebio	1894		
Parrocchia di S. Felice	1895		
Parrocchia di S. Spirito	1896		
Parrocchia di S. Gerolamo	1897		
Parrocchia di S. Barnaba	1898		
Parrocchia di S. Vito	1899		
Parrocchia di S. Carlo	1900		











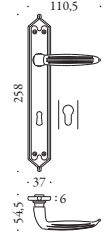







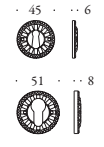

# Louis XVI

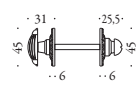
*Mi alzai e percorsi il corridoio che  
portava alla stanza dove avevo  
lasciato il Viaggiatore nel tempo.  
Proprio mentre stavo premendo la  
maniglia della porta sentii  
un'esclamazione interrotta, uno  
scatto metallico, un tonfo.  
Nella stanza, un turbinare  
dell'aria, il suono di un cristallo  
che si rompeva sul pavimento.  
Il Viaggiatore e la macchina non  
c'erano più.*

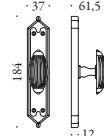
*Herbert George Wells,  
La macchina del tempo (1895)*

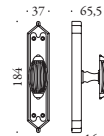
*I got up and went down the passage  
to tell the Time Traveller:  
As I took hold of the handle of the  
door I heard an exclamation,  
oddly truncated at the end, and a  
click and a thud.  
A gust of air whirled round me as  
I opened the door,  
and from within came the sound of  
broken glass falling on the floor.  
The Time Traveller was not there.*

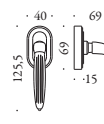
*Herbert George Wells,  
The Time Machine (1895)*

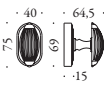
<p><b>MANIGLIA SU PLACCA HANDLE ON PLATE</b></p>			<p>35 <math>\div</math> 45 8 i Senza molla Without spring</p>		<p><b>KLU11 PB70 170 KLU11 PB90 190 KLU11 PBY85 185</b></p>	<p>ON BR AG</p>	
<p><b>MANIGLIA SU ROSETTA HANDLE ON ROSE</b></p>			<p>41 <math>\div</math> 51 8 i Senza molla Without spring</p>		<p><b>KLU11 RB Ø45 KLU11 RBY Ø50</b></p>	<p>ON BR AG</p>	
			<p>38 <math>\div</math> 48 8 i Con molla With spring</p>		<p><b>KLU11 R Ø45 KLU11 RY Ø50</b></p>	<p>ON BR AG</p>	
<p><b>BOCCHETTE ESCUTCHEONS</b></p> 			<p>40 <math>\div</math> 50 8</p>		<p><b>KLU13 BP Ø45 KLU13 BY (Y) Ø50</b></p>	<p>ON BR AG</p>	
<p><b>NOTTOLINI TOILET ROSES</b></p> 			<p>35 <math>\div</math> 45 6</p>		<p><b>KLU19 BZG 6B Ø45</b></p>	<p>ON BR AG</p>	
<p><b>MANIGLIA PER FINESTRA HANDLE FOR WINDOW</b></p>			<p>7 i</p>		<p><b>KLU12 B</b></p>	<p>ON BR AG</p>	
			<p>Movimento non incluso Mechanism excluded</p>		<p><b>KLU12</b></p>	<p>ON BR AG</p>	
<p><b>MANIGLIA PER FINESTRA DREH-KIPP DREH-KIPP HANDLE FOR WINDOW</b></p>			<p>i Movimento non incluso Mechanism excluded</p>		<p><b>KLU12 DK/SM</b></p>	<p>ON BR AG</p>	
			<p>i Movimento non incluso Mechanism excluded</p>		<p><b>KLU12 CRDK</b></p>	<p>ON BR AG</p>	



# Louis XVI



**ON** Ottone naturale non verniciato  
Natural brass not lacquered



**BR** Bronzo non verniciato  
Bronze not lacquered



**AG** Argento naturale non verniciato  
Natural silver not lacquered



**AG** Argento naturale non verniciato  
Natural silver not lacquered



**ON** Ottone naturale non verniciato  
Natural brass not lacquered



**ON** Ottone naturale non verniciato  
Natural brass not lacquered



# Ottocento

*La sala era ampia, la luce pioveva dall'alto e un'intera parete appariva ricoperta da una mostra di armi d'ogni foggia, gelida collezione di acciai su uno sfondo di stuoie e drappi.*

*Una piccola porta la metteva in comunicazione con lo studio. Dovevo solo allungare la mano e, fatto un passo, avrei raggiunto la magnifica maniglia di bronzo dell'usciole in ebano.*











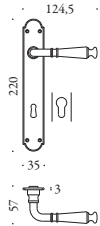







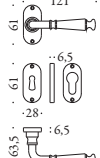

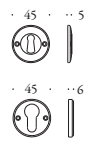
*Joseph Conrad,  
La freccia d'oro (1919)*

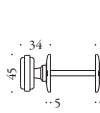
*That room was very large, lighted from the top, and one wall of it was covered by trophies of arms of all sorts, a choice collection of cold steel disposed on a background of Indian mats and rugs.*

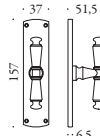
*Blunt used it as a dressing-room. It communicated by a small door with the studio.*

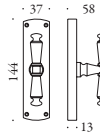
*I had only to extend my hand and make one step to reach the magnificent bronze handle of the ebony door.*

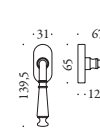
*Joseph Conrad,  
The arrow of Gold (1919)*

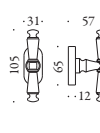
<p><b>MANIGLIA SU PLACCA HANDLE ON PLATE</b></p>			<p>42 <math>\div</math> 52 8 i Senza molla Without spring</p>		<p><b>KOT11 PB70 I 70 KOT11 PB90 I 90 KOT11 PBY85 I 85</b></p>	<p>● ON ● BR ● AG</p>	
<p><b>MANIGLIA SU ROSETTA HANDLE ON ROSE</b></p>			<p>40 <math>\div</math> 54 8 i Senza molla Without spring</p>		<p><b>KOT11 RB Ø45 KOT11 RBY Ø45</b></p>	<p>● ON ● BR ● AG</p>	
<p><b>MANIGLIA SU ROSETTA HANDLE ON ROSE</b></p>			<p>33 <math>\div</math> 47 8 i Con molla With spring</p>		<p><b>KOT11 R Ø45 KOT11 RY Ø45</b></p>	<p>● ON ● BR ● AG</p>	
<p><b>MANIGLIA SU ROSETTA HANDLE ON ROSE</b></p>			<p>37 <math>\div</math> 51 8 i Senza molla Without spring</p>		<p><b>KOT11 RBO 28x61 KOT11 RBOY 28x61</b></p>	<p>● ON ● BR ● AG</p>	
<p><b>BOCCHETTE ESCUTCHEONS</b></p>					<p><b>KOT13 BP Ø45 KOT13 BY (Y) Ø45</b></p>	<p>● ON ● BR ● AG</p>	
<p><b>NOTTOLINI TOILET ROSES</b></p>			<p>35 <math>\div</math> 45 6</p>		<p><b>KOT19 BZG 6B Ø45</b></p>	<p>● ON ● BR ● AG</p>	
<p><b>MANIGLIA PER FINESTRA HANDLE FOR WINDOW</b></p>			<p>7 i</p>		<p><b>KOT12 B</b></p>	<p>● ON ● BR ● AG</p>	
<p><b>MANIGLIA PER FINESTRA HANDLE FOR WINDOW</b></p>			<p>Movimento non incluso Mechanism excluded</p>		<p><b>KOT12</b></p>	<p>● ON ● BR ● AG</p>	
<p><b>MANIGLIA PER FINESTRA DREH-KIPP DREH-KIPP HANDLE FOR WINDOW</b></p>			<p>i Movimento non incluso Mechanism excluded</p>		<p><b>KOT12 DK/SM</b></p>	<p>● ON ● BR ● AG</p>	
<p><b>MANIGLIA PER FINESTRA DREH-KIPP DREH-KIPP HANDLE FOR WINDOW</b></p>			<p>i Movimento non incluso Mechanism excluded</p>		<p><b>KOT12 CRDK</b></p>	<p>● ON ● BR ● AG</p>	

**i** Finiture verniciate disponibili su richiesta (vedi 2a di copertina)  
Lacquered finishes available on request (see back cover)

**i** Modelli e finiture speciali forniti su richiesta (vedi 2a di copertina)  
Model and finishes available on request (see back cover)

# Ottocento



**AG** Argento naturale non verniciato  
Natural silver not lacquered



**ON** Ottone naturale non verniciato  
Natural brass not lacquered



**BR** Bronzo non verniciato  
Bronze not lacquered

**ON** Ottone naturale non verniciato  
Natural brass not lacquered

**AG** Argento naturale non verniciato  
Natural silver not lacquered



**ON** Ottone naturale non verniciato  
Natural brass not lacquered



OTTORINO RESPIGHI

# 4 LIRICHE

PER CANTO E PIANOFO



RICOR











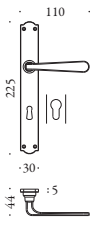





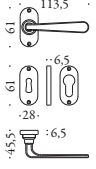

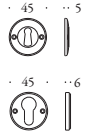

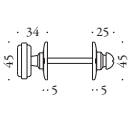
# Palatino

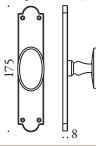
*La porta girava quasi da sola;  
e la maniglia, liscia al tatto,  
aveva la dolcezza e come l'intesa  
di una mano nella sua mano.*

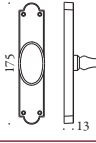
*Gustave Flaubert,  
L'educazione sentimentale (1869)*

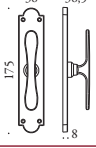
*The door almost opened of its own  
accord; and the handle, smooth to  
the touch, gave him the sensation  
of friendly and, as it were,  
intelligent fingers clasping his.*

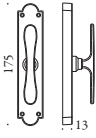
*Gustave Flaubert,  
Sentimental education (1869)*

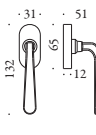
<p><b>MANIGLIA SU PLACCA</b> HANDLE ON PLATE</p>			<p>45 <math>\div</math> 56 8 i Senza molla Without spring</p>	<p>1 C</p>	<p>KPA11 PB70 I 70 KPA11 PB90 I 90 KPA11 PBY85 I 85</p>	<p>ON BR NI</p>	
<p><b>MANIGLIA SU ROSETTA</b> HANDLE ON ROSE</p>			<p>42 <math>\div</math> 55 8 i Senza molla Without spring</p>		<p>KPA11 RB Ø45 KPA11 RBY Ø45</p>	<p>ON BR NI</p>	
			<p>40 <math>\div</math> 52 8 i Con molla With spring</p>	<p>1 C</p>	<p>KPA11 R Ø45 KPA11 RY Ø45</p>	<p>ON BR NI</p>	
			<p>39 <math>\div</math> 52 8 i Senza molla Without spring</p>		<p>KPA11 RBO 28x61 KPA11 RBOY 28x61</p>	<p>ON BR NI</p>	
<p><b>BOCCHETTE ESCUTCHEONS</b></p>				<p>10 S</p>	<p>KOT13 BP Ø45 KOT13 BY (Y) Ø45</p>	<p>ON BR NI</p>	
<p><b>NOTTOLINI TOILET ROSES</b></p>			<p>35 <math>\div</math> 45 6 S</p>	<p>2 S</p>	<p>KOT19 BZG 6B Ø45</p>	<p>ON BR NI</p>	
<p><b>MANIGLIA PER FINESTRA</b> HANDLE FOR WINDOW</p>			<p>7 i Movimento non incluso Mechanism excluded</p>		<p>KPA12 B</p>	<p>ON BR NI</p>	
			<p>Movimento non incluso Mechanism excluded</p>	<p>1 S</p>	<p>KPA12</p>	<p>ON BR NI</p>	
			<p>7 i Movimento non incluso Mechanism excluded</p>		<p>KPA22 B</p>	<p>ON BR NI</p>	
			<p>Movimento non incluso Mechanism excluded</p>		<p>KPA22</p>	<p>ON BR NI</p>	
<p><b>MANIGLIA PER FINESTRA DREH-KIPP</b> DREH-KIPP HANDLE FOR WINDOW</p>			<p>i Movimento non incluso Mechanism excluded</p>	<p>1 S</p>	<p>KPA12 DK/SM</p>	<p>ON BR NI</p>	



# Palatino



**NI** Nichel naturale non verniciato  
Natural nickel not lacquered



**ON** Ottone naturale non verniciato  
Natural brass not lacquered



**BR** Bronzo non verniciato  
Bronze not lacquered

**NI** Nichel naturale non verniciato  
Natural nickel not lacquered



**ON** Ottone naturale non verniciato  
Natural brass not lacquered



**BR** Bronzo non verniciato  
Bronze not lacquered



J. Allart del.

TAINÉ AUGU



RAI  
DOD'S  
RÉNÉ  
RANDARD,  
colours. The  
music, specially  
Réné Favarger,  
Stephen Heller,  
M...

VUE DU RHONE PRE

WALTZES.  
Introducing "Il Bacio"  
209, Regent-street.  
MUSICAL CHRISTMA  
THE EXHIBITION











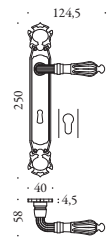



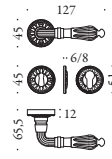

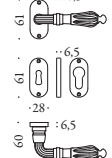

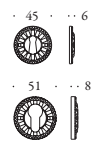
# Roma

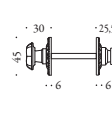
*Gadda si sistemò in una stanza  
insieme a un funzionario giovane  
di anni, ma un po' meno di  
aspetto, aggrottato e taciturno.  
Preferì che le due scrivanie fossero  
collocate una accanto all'altra  
proprio per non avere di fronte il  
corrugatissimo collega.  
Questo parlava poco, almeno nei  
primi giorni, ma si alzava  
continuamente fermandosi  
perplesso davanti alla porta con la  
mano sulla maniglia, poi apriva  
uno spiraglio con relativo cigolio e  
indugiava ancora pensoso mentre  
l'interiore incertezza gli si  
disegnava sulla fronte,  
moltiplicandone le rughe.*

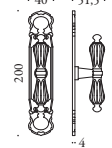
*Giulio Cattaneo,  
Il gran lombardo (1911)*

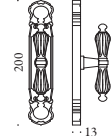
*Gadda settled in a room with an  
official younger by years, but a bit  
less in appearance, frowning and  
silent.  
He preferred that the two desks  
were placed side by side in order  
not to have in front the corrugated  
colleague.  
This spoke little, at least in the early  
days, but he was used to get up  
continuously and stop perplexed in  
front of the door with his hand on  
the handle, then he was opening a  
glimmer with relative creaking and  
was delaying thoughtfully while the  
internal uncertainty was drawing  
himself on his forehead, multiplying  
the wrinkles.*

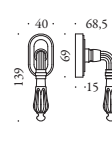
*Giulio Cattaneo,  
Il gran lombardo (1911)*

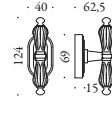
<p><b>MANIGLIA SU PLACCA HANDLE ON PLATE</b></p>			<p>40 <math>\div</math> 55 8 i Senza molla Without spring</p>	<p>1 C</p>	<p>KSE21 PB70 170 KSE21 PB90 190 KSE21 PBY85 185</p>	<p>● ON</p>	
<p><b>MANIGLIA SU ROSETTA HANDLE ON ROSE</b></p>			<p>39 <math>\div</math> 52 8 i Senza molla Without spring</p>		<p>KSE21 RB Ø45 KSE21 RBY Ø50</p>	<p>● ON</p>	
			<p>42 <math>\div</math> 55 8 i Con molla With spring</p>	<p>1 C</p>	<p>KSE21 R Ø45 KSE21 RY Ø50</p>	<p>● ON</p>	
			<p>39 <math>\div</math> 52 8 i Senza molla Without spring</p>		<p>KSE21 RBO 28x61 KSE21 RBOY 28x61</p>	<p>● ON</p>	
<p><b>BOCCHETTE ESCUTCHEONS</b></p>				<p>10 S</p>	<p>KLU13 BP Ø45 KLU13 BY (Y) Ø50</p>	<p>● ON</p>	
<p><b>NOTTOLINI TOILET ROSES</b></p>			<p>35 <math>\div</math> 45 6</p>	<p>2 S</p>	<p>KSE19 BZG 6B Ø45</p>	<p>● ON</p>	
<p><b>MANIGLIA PER FINESTRA HANDLE FOR WINDOW</b></p>			<p>7 i Movimento non incluso Mechanism excluded</p>	<p>1 S</p>	<p>KSE22 B</p>	<p>● ON</p>	
					<p>KSE22</p>	<p>● ON</p>	
<p><b>MANIGLIA PER FINESTRA DREH-KIPP DREH-KIPP HANDLE FOR WINDOW</b></p>			<p>i Movimento non incluso Mechanism excluded</p>	<p>1 S</p>	<p>KSE22 DK/SM</p>	<p>● ON</p>	
			<p>i Movimento non incluso Mechanism excluded</p>		<p>KSE22 CRDK</p>	<p>● ON</p>	



**ON** Ottone naturale non verniciato  
Natural brass not lacquered



**ON** Ottone naturale non verniciato  
Natural brass not lacquered



**ON** Ottone naturale non verniciato  
Natural brass not lacquered



**ON** Ottone naturale non verniciato  
Natural brass not lacquered





...re. Copyrighted in the U.S.A.

...S KEANE IN "R...  
...hibited in 19...











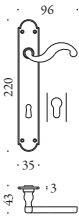

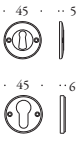

# Settecento

*Tra i particolari che mi erano sfuggiti a un primo sguardo notai che dalla maniglia della porta da cui ero entrato pendeva una rossa crinolina ...*

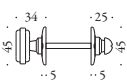
*Charles Dickens,  
The uncommercial Traveller (1861)*

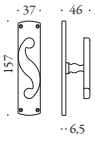
*I had missed, at the first glance, some half a pound of bread in the otherwise empty safe, an old red ragged crinoline hanging on the handle of the door by which I had entered, and certain fragments of rusty iron scattered on the floor, ...*

*Charles Dickens,  
The uncommercial Traveller (1861)*

<p><b>MANIGLIA SU PLACCA HANDLE ON PLATE</b></p>			<p>42 <math>\div</math> 57 8 i Senza molla Without spring</p>		<p>KSE11 PB70 170 KSE11 PB90 190 KSE11 PBY85 185</p>	<p>● ON ● BR ● AG</p>	
<p><b>MANIGLIA SU ROSETTA HANDLE ON ROSE</b></p>			<p>38 <math>\div</math> 56 8 i Senza molla Without spring</p>		<p>KSE11 RB Ø45 KSE11 RBY Ø45</p>	<p>● ON ● BR ● AG</p>	
<p><b>BOCCHETTE ESCUTCHEONS</b></p>			<p>35 <math>\div</math> 54 8 i Con molla With spring</p>		<p>KOT13 BP Ø45 KOT13 BY (Y) Ø45</p>	<p>● ON ● BR ● AG</p>	
<p><b>NOTTOLINI TOILET ROSES</b></p>			<p>35 <math>\div</math> 45 6 S</p>		<p>KOT19 BZG 6B Ø45</p>	<p>● ON ● BR ● AG</p>	
<p><b>MANIGLIA PER FINESTRA HANDLE FOR WINDOW</b></p>			<p>7 i Movimento non incluso Mechanism excluded</p>		<p>KSE12 B</p>	<p>● ON ● BR ● AG</p>	
<p><b>MANIGLIA PER FINESTRA DREH-KIPP DREH-KIPP HANDLE FOR WINDOW</b></p>			<p>i Movimento non incluso Mechanism excluded</p>		<p>KSE12 DK/SM</p>	<p>● ON ● BR ● AG</p>	





**ON Ottone naturale non verniciato**  
Natural brass not lacquered



**BR Bronzo non verniciato**  
Bronze not lacquered



**AG Argento naturale non verniciato**  
Natural silver not lacquered

**AG Argento naturale non verniciato**  
Natural silver not lacquered



**ON Ottone naturale non verniciato**  
Natural brass not lacquered













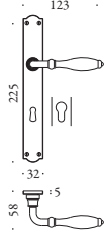

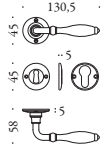

# *Siena*

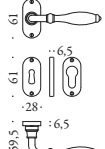
*Io avrei intitolato quel dipinto  
La tentazione, perché la mia  
mano destra vi afferra una  
maniglia, la abbassa, e apre  
una stanza in cui si trova ...*

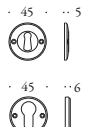
*Günter Grass,  
Il tamburo di latta (1959)*

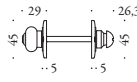
*I would have called that  
picture «The Temptation»  
because my right hand grabs  
a handle, lowers it, and  
enters a room where there is ...*

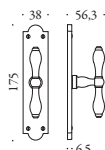
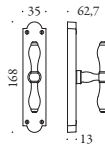
*Günter Grass,  
The tin drum (1959)*

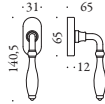
<p><b>MANIGLIA SU PLACCA HANDLE ON PLATE</b></p>			<p>40 <math>\div</math> 55 8 i Senza molla Without spring</p>	<p>1 C</p>	<p>KSI11 PB70 170 KSI11 PB90 190 KSI11 PBY85 185</p>	<p>ON BR NI</p>	
<p><b>MANIGLIA SU ROSETTA HANDLE ON ROSE</b></p>			<p>40 <math>\div</math> 55 8 i Senza molla Without spring</p>	<p>1 C</p>	<p>KSI11 RB 045 KSI11 RBY 045</p>	<p>ON BR NI</p>	
			<p>40 <math>\div</math> 55 8 i Con molla With spring</p>		<p>KSI11 R 045 KSI11 RY 045</p>	<p>ON BR NI</p>	
			<p>40 <math>\div</math> 55 8 i Senza molla Without spring</p>		<p>KSI11 RBO 28x61 KSI11 RBOY 28x61</p>	<p>ON BR NI</p>	
<p><b>BOCCHETTE ESCUTCHEONS</b></p>				<p>10 S</p>	<p>KOT13 BP 045 KOT13 BY (Y) 045</p>	<p>ON BR AG</p>	
<p><b>NOTTOLINI TOILET ROSES</b></p>			<p>35 <math>\div</math> 45 6</p>	<p>2 S</p>	<p>KSI19 BZG 6B 045</p>	<p>ON BR NI</p>	
<p><b>MANIGLIA PER FINESTRA HANDLE FOR WINDOW</b></p>			<p>7 i Movimento non incluso Mechanism excluded</p>	<p>1 S</p>	<p>KSI12 B</p>	<p>ON BR NI</p>	
			<p>KSI12</p>		<p>ON BR NI</p>		
<p><b>MANIGLIA PER FINESTRA DREH-KIPP HANDLE FOR WINDOW</b></p>			<p>i Movimento non incluso Mechanism excluded</p>	<p>1 S</p>	<p>KSI12 DK/SM</p>	<p>ON BR NI</p>	



**ON** Ottone naturale non verniciato  
Natural brass not lacquered



**BR** Bronzo non verniciato  
Bronze not lacquered



**NI** Nichel naturale non verniciato  
Natural nickel not lacquered

**ON** Ottone naturale non verniciato  
Natural brass not lacquered

**NI** Nichel naturale non verniciato  
Natural nickel not lacquered





The famous Bridge of Rialto at Venice  
built with white Marble.











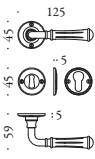

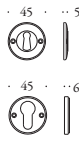
# Venezia

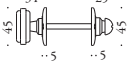
*E Du Roy disse: "Sono io. E' inutile  
che cercate di farcela."  
Il passo leggero, un rumore di piedi  
scalzi, s'allontanò, poi tornò in  
capo a qualche secondo.  
Georges disse: "Se vi rifiutate  
d'aprire, sfonderemo la porta."  
Tenne stretta la maniglia d'ottone,  
e adagio si mise a spingere  
con una spalla.*

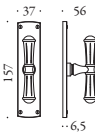
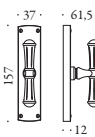
*Guy de Maupassant,  
Bel Ami (1885)*

*Du Roy said: "It is I. It is useless to  
seek to escape."  
The light steps, the tread of bare feet,  
was heard to withdraw, and then in  
a few seconds to return.  
George said: "If you won't open,  
we will break in the door".  
He grasped the handle, and pushed  
slowly with his shoulder.*

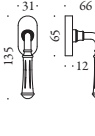
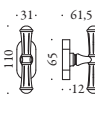
*Guy de Maupassant,  
Bel Ami (1885)*

<p><b>MANIGLIA SU ROSETTA HANDLE ON ROSE</b></p>			<p>40 <math>\div</math> 55 8 i Senza molla Without spring</p>		<p><b>KVE11 RB Ø45 KVE11 RBY Ø45</b></p>	<p>● ON ● BR</p>	
<p><b>BOCCHETTE ESCUTCHEONS</b></p>					<p><b>KOT13 BP Ø45 KOT13 BY (Y) Ø45</b></p>	<p>● ON ● BR</p>	
<p><b>NOTTOLINI TOILET ROSES</b></p>			<p>35 <math>\div</math> 45 6</p>		<p><b>KOT19 BZG 6B Ø45</b></p>	<p>● ON ● BR</p>	
<p><b>MANIGLIA PER FINESTRA HANDLE FOR WINDOW</b></p>		 	<p>7 i Movimento non incluso Mechanism excluded</p>		<p><b>KVE12 B</b></p>	<p>● ON ● BR</p>	
<p><b>MANIGLIA PER FINESTRA DREH-KIPP DREH-KIPP HANDLE FOR WINDOW</b></p>	 	 	<p>i Movimento non incluso Mechanism excluded</p>		<p><b>KVE12 DK/SM</b></p>	<p>● ON ● BR</p>	
			<p>i Movimento non incluso Mechanism excluded</p>		<p><b>KVE12 CRDK</b></p>	<p>● ON ● BR</p>	



# Venezia



**BR** Bronzo non verniciato  
Bronze not lacquered



**ON** Ottone naturale non verniciato  
Natural brass not lacquered

**BR** Bronzo non verniciato  
Bronze not lacquered

**BR** Bronzo non verniciato  
Bronze not lacquered

**ON** Ottone naturale non verniciato  
Natural brass not lacquered





*Nottolini*  
*Toilet roses*

<i>Accademia</i>			35 ÷ 45			KAC19 BZG 6B Ø45	<ul style="list-style-type: none"> <li> ON</li> <li> BR</li> <li> AG</li> </ul>
<i>Barocco</i>			35 ÷ 45			KBA19 BZG 6G Ø50	<ul style="list-style-type: none"> <li> ON</li> <li> BR</li> <li> AG</li> </ul>
<i>Bellagio Busiri</i>			35 ÷ 45			KBU19 BZG 6B 36,5x48,5	<ul style="list-style-type: none"> <li> ON</li> <li> BR</li> <li> CR</li> <li> AG</li> </ul>
<i>Byblos</i>			40 ÷ 50			KBY19 BZG 6B Ø55	<ul style="list-style-type: none"> <li> OLV</li> <li> BSV</li> </ul>
<i>Capri</i>			35 ÷ 45			KCR19 BZG 6B Ø45	<ul style="list-style-type: none"> <li> ON</li> <li> BR</li> </ul>
<i>Firenze Lidia Ottocento Palatino Settecento Venezia</i>			35 ÷ 45			KOT19 BZG 6B Ø45	<ul style="list-style-type: none"> <li> ON</li> <li> BR</li> <li> NI</li> <li> CR</li> <li> AG</li> </ul>
<i>Impero</i>			35 ÷ 45			KIM19 BZG 6B Ø45	<ul style="list-style-type: none"> <li> ON</li> <li> BR</li> <li> AG</li> </ul>
Versione con rosetta maggiorata (Ø52) disponibile su richiesta Version with increased rose (Ø52) available on request							
<i>Louis XVI</i>			35 ÷ 45			KLU19 BZG 6B Ø45	<ul style="list-style-type: none"> <li> ON</li> <li> BR</li> <li> AG</li> </ul>
<i>Roma</i>			35 ÷ 45			KSE19 BZG 6B Ø45	<ul style="list-style-type: none"> <li> ON</li> </ul>
<i>Stena</i>			35 ÷ 45			KS119 BZG 6B Ø45	<ul style="list-style-type: none"> <li> ON</li> <li> BR</li> <li> NI</li> </ul>

**Accademia**  
KAC19 BZG 6B



**Firenze, Lidia, Ottocento, Palatino, Settecento, Venezia**  
KOT19 BZG 6B



**Barocco**  
KBA19 BZG 6G



**Impero**  
KIM19 BZG 6B



**Bellagio, Busiri**  
KBU19 BZG 6B



**Louis XVI**  
KLU19 BZG 6B



**Byblos**  
KBY19 BZG 6B



**Roma**  
KSE19 BZG 6B



**Capri**  
KCR19 BZG 6B



**Siena**  
KSI19 BZG 6B

























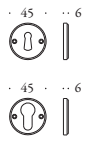















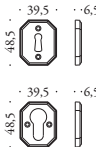







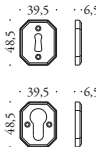



















*Pomoli*  
*Door knobs*

# Pomoli girevoli *Turned door knobs*

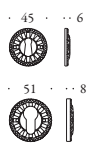
materiale: ottone  
material: brass

<b>POMOLO SU ROSETTA DOOR KNOB ON ROSE</b>	<b>Accademia</b>		32 $\div$ 47   Senza molla Without spring	 	<b>KAC15 RB Ø45</b> <b>KAC15 RBY Ø45</b>	 ON  BR  AG
			32 $\div$ 47   Con molla With spring		<b>KAC15 R Ø45</b> <b>KAC15 RY Ø45</b>	 ON  BR  AG
<b>BOCCHETTE ESCUTCHEONS</b> 				 	<b>KAC13 BP Ø45</b> <b>KAC13 BY (Y) Ø45</b>	 ON  BR  AG

<b>POMOLO SU ROSETTA DOOR KNOB ON ROSE</b>	<b>Busiri</b>		40 $\div$ 50   Con molla With spring	 	<b>KBU15 R 39,5x60</b> <b>KBU15 RY 39,5x60</b>	 ON  BR  AG  CR
			40 $\div$ 50   Con molla With spring		<b>KBU13 BP 39,5x48,5</b> <b>KBU13 BY (Y) 39,5x48,5</b>	 ON  BR  AG  CR
<b>BOCCHETTE ESCUTCHEONS</b> 				 	<b>KBU13 BP 39,5x48,5</b> <b>KBU13 BY (Y) 39,5x48,5</b>	 ON  BR  AG  CR

<b>POMOLO SU ROSETTA DOOR KNOB ON ROSE</b>	<b>Louis XVI</b>		32 $\div$ 47   Senza molla Without spring	 	<b>KLU15 RB Ø45</b> <b>KLU15 RBY Ø50</b>	 ON  BR  AG
			30 $\div$ 45   Con molla With spring		<b>KLU15 R Ø45</b> <b>KLU15 RY Ø50</b>	 ON  BR  AG
<b>BOCCHETTE ESCUTCHEONS</b> 				 	<b>KLU13 BP Ø45</b> <b>KLU13 BY (Y) Ø50</b>	 ON  BR  AG

 Finiture verniciate disponibili su richiesta (vedi 2a di copertina)  
Lacquered finishes available on request (see back cover)

 Modelli e finiture speciali forniti su richiesta (vedi 2a di copertina)  
Model and finishes available on request (see back cover)



# *Pomoli girevoli* Turned door knobs



**Accademia KAC15 RBY**  
ON Ottone naturale non verniciato  
Natural brass not lacquered



**Louis XVI KLU15 RB**  
ON Ottone naturale non verniciato  
Natural brass not lacquered



**Busiri KLU15 RB**  
ON Ottone naturale non verniciato  
Natural brass not lacquered



# Pomoli girevoli *Turned door knobs*

materiale: ottone  
material: brass

<b>POMOLO SU ROSETTA DOOR KNOB ON ROSE</b>	<b>Ottocento</b>		<b>34 ÷ 49</b>  <i>i</i> Senza molla Without spring	 	<b>KOT15 RB Ø45</b> <b>KOT15 RBY Ø45</b>	ON BR AG NI
			<b>31 ÷ 46</b>  <i>i</i> Con molla With spring		<b>KOT15 R Ø45</b> <b>KOT15 RY Ø45</b>	ON BR AG NI
<b>BOCCHETTE ESCUTCHEONS</b> 				 	<b>KOT13 BP Ø45</b> <b>KOT13 BY (Y) Ø45</b>	ON BR AG NI

<b>POMOLO SU ROSETTA DOOR KNOB ON ROSE</b>	<b>Roma</b>		<b>32 ÷ 47</b>  <i>i</i> Senza molla Without spring	 	<b>KSE15 RB Ø45</b> <b>KSE15 RBY Ø50</b>	ON
					 	<b>KLU13 BP Ø45</b> <b>KLU13 BY (Y) Ø50</b>

<b>POMOLO SU ROSETTA DOOR KNOB ON ROSE</b>	<b>Versailles</b>		<b>40 ÷ 50</b>  <i>i</i> Senza molla Without spring	 	<b>KLU25 RB 50x34</b> <b>KLU25 RBY 50x34</b>	ON
					 	<b>KLU23 BP 50x34</b> <b>KLU23 BY (Y) 50x34</b>

# *Pomoli girevoli* Turned door knobs



**Ottocento KOT15 RB**  
ON Ottone naturale non verniciato  
Natural brass not lacquered



**Roma KSE15 RBY**  
ON Ottone naturale non verniciato  
Natural brass not lacquered



**Versailles KLU25 RB**  
ON Ottone naturale non verniciato  
Natural brass not lacquered



# Pomoli fissi *Fixed door knobs*

materiale: ottone  
material: brass

<b>POMOLO FISSO FIXED DOOR KNOB</b>	<b>Busiri</b>			<b>KBU25 FISSO 70x70</b>	
				<b>KBU35 FISSO 110x110</b>	
	<b>Byblos</b>			<b>KBY15 FISSO Ø120</b>	
				<b>KBY25 FISSO Ø120</b>	
	<b>Doge</b>			<b>KDO 15 FISSO Ø119,5</b>	

Istruzione montaggio pag. 137  
Mounting instruction page 137

# *Pomoli fissi* Fixed door knobs

## **Busiri KBU25 FISSO**

**ON** Ottone naturale non verniciato  
Natural brass not lacquered



## **Busiri KBU35 FISSO**

**ON** Ottone naturale non verniciato  
Natural brass not lacquered



## **Doge KDO 15 FISSO**

**ON** Ottone naturale non verniciato  
Natural brass not lacquered

## **Byblos KBY15 FISSO**

**OLV** Ottone lucido verniciato  
Lacquered polished brass



## **Byblos KBY25 FISSO**

**BSV** Bronzo satinato verniciato  
Lacquered satin bronze



# Pomoli per mobile Furniture door knobs

materiale: ottone  
material: brass

<b>POMOLO PER MOBILE FURNITURE KNOB</b>	<i>Accademia</i>			KAC119 25x37	
	<i>Busiri</i>			KBU119/A 28x30	
				KBU119/B 25x22	
				KBU119/C 16x14	
		<i>Capri</i>			KCR119 Ø21
	<i>Impero</i>			KIM119 Ø26,5	
	<i>Louis XVI</i>			KLU119 19,5x45,5	
	<i>Roma</i>			KSE119 Ø26,5	

Fornito di vite M4x30mm  
M4x30 screw included

Finiture verniciate disponibili su richiesta (vedi 2a di copertina)  
Lacquered finishes available on request (see back cover)

Modelli e finiture speciali forniti su richiesta (vedi 2a di copertina)  
Model and finishes available on request (see back cover)

# Pomoli per mobile Furniture door knobs



**Accademia KAC119**  
NI Nichel naturale non verniciato  
Natural nickel not lacquered



**Busiri KBU119/A**  
AG Argento naturale non verniciato  
Natural silver not lacquered



**Busiri KBU119/B**  
BR Bronzo non verniciato  
Bronze not lacquered



**Busiri KBU119/C**  
ON Ottone naturale non verniciato  
Natural brass not lacquered



**Capri KCR119**  
ON Ottone naturale non verniciato  
Natural brass not lacquered



**Impero KIM119**  
ON Ottone naturale non verniciato  
Natural brass not lacquered



**Louis XVI KLU119**  
AG Argento naturale non verniciato  
Natural silver not lacquered



**Roma KSE119**  
ON Ottone naturale non verniciato  
Natural brass not lacquered



IN THE DINING-ROOM OF OSBORNE HOUSE.



*Maniglioni e  
battiporta*  
*Pulls and door knockers*

<i>Busiri</i>		<p>Maniglione dritto completo di accessori per il fissaggio passante singolo con copridadi interni. Straight pull handle complete with single through fixing accessories and internal bolts.</p>	INT <b>320</b>  <b>S</b>	<b>KBU16</b>	
		<p>Maniglione dritto completo di accessori per il fissaggio non passante (con viti a vista). Straight pull handle complete with surface fixing kit (with exposed screws).</p>	INT <b>230</b>  <b>S</b>	<b>KBU26NP</b>	
		<p>Maniglione dritto completo di accessori per il fissaggio passante singolo con copridadi interni. Straight pull handle complete with single through fixing accessories and internal bolts.</p>	INT <b>230</b>  <b>S</b>	<b>KBU26PS</b>	
<i>Barocco</i>		<p>Maniglione dritto privo di kit di fissaggio PS e PA da acquistare separatamente. Straight pull handle. Pulls price with PS and PA fixing kit NOT included to be purchased separately.</p>	INT <b>250</b>  <b>S</b>	<b>KBA16</b>	
		<p><b>KIT PS</b> Passante Singolo (acciaio-ottone) Single pull-bolt through (steel-brass)</p>	 <b>S</b>	<b>KITPS</b>	
		<p><b>KIT PA</b> Passante Accoppiato (acciaio) Back to back (steel)</p>	 <b>S</b>	<b>KITPA</b>	



**Busiri KBU16**  
ON Ottone naturale non verniciato  
Natural brass not lacquered



**Busiri KBU26**  
BR Bronzo non verniciato  
Bronze not lacquered



**Barocco BA16**  
AG Argento naturale non verniciato  
Natural silver not lacquered

## Byblos

	<p>Maniglione dritto privo di kit di fissaggio PS e PA da acquistare separatamente Straight pull handle. Pulls price with PS and PA fixing kit NOT included to be purchased separately.</p>	<p>INT 220</p> <p>1</p> <p>S</p>	<p><b>KBY16</b></p>	<p>● OLV ● BSV</p>
	<p>KIT PS Passante Singolo (acciaio-ottone) Single pull-bolt through (steel-brass)</p>	<p>5</p> <p>S</p>	<p><b>KITPS</b></p>	<p>● OLV ● BSV</p>
	<p>KIT PA Passante Accoppiato (acciaio) Back to back (steel)</p>	<p>5</p> <p>S</p>	<p><b>KITPA</b></p>	
	<p>Maniglione dritto completo di accessori per il fissaggio non passante (con viti a vista). Straight pull handle complete with surface fixing kit (with exposed screws).</p>	<p>INT 220</p> <p>1</p> <p>S</p>	<p><b>KBY16NP</b></p>	<p>● OLV ● BSV</p>
	<p>Maniglione dritto privo di kit di fissaggio PS e PA da acquistare separatamente Straight pull handle. Pulls price with PS and PA fixing kit NOT included to be purchased separately.</p>	<p>INT 300</p> <p>1</p> <p>S</p>	<p><b>KBY26</b></p>	<p>● OLV ● BSV</p>
	<p>KIT PS Passante Singolo (acciaio-ottone) Single pull-bolt through (steel-brass)</p>	<p>5</p> <p>S</p>	<p><b>KITPS</b></p>	<p>● OLV ● BSV</p>
	<p>KIT PA Passante Accoppiato (acciaio) Back to back (steel)</p>	<p>5</p> <p>S</p>	<p><b>KITPA</b></p>	
	<p>Maniglione dritto completo di accessori per il fissaggio non passante (con viti a vista). Straight pull handle complete with surface fixing kit (with exposed screws).</p>	<p>INT 300</p> <p>1</p> <p>S</p>	<p><b>KBY26NP</b></p>	<p>● OLV ● BSV</p>



**Byblos KBY26**  
**OLV** Ottone lucido verniciato  
Lacquered polished brass



**Byblos KBY16**  
**BSV** Bronzo satinato verniciato  
Lacquered satin bronze

## Capri

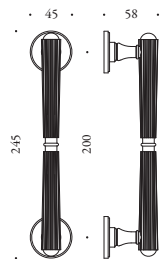

Maniglione dritto  
privo di kit di fissaggio PS e PA  
da acquistare separatamente  
Straight pull handle.  
Pulls price with PS and PA fixing kit  
NOT included to be purchased  
separately.

INT  
200  
1  
S

KCR16

● ON  
● BR

 KIT PS  
Passante Singolo  
(acciaio-ottone)  
Single pull-bolt through  
(steel-brass)

5  
S

KITPS

● ON  
● BR

 KIT PA  
Passante Accoppiato  
(acciaio)  
Back to back (steel)

5  
S

KITPA

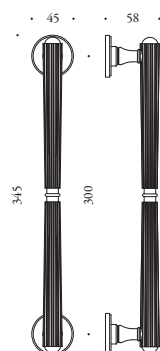

Maniglione dritto  
privo di kit di fissaggio PS e PA  
da acquistare separatamente  
Straight pull handle.  
Pulls price with PS and PA fixing kit  
NOT included to be purchased  
separately.

INT  
300  
1  
S

KCR26

● ON  
● BR

 KIT PS  
Passante Singolo  
(acciaio-ottone)  
Single pull-bolt through  
(steel-brass)

5  
S

KITPS

● ON  
● BR

 KIT PA  
Passante Accoppiato  
(acciaio)  
Back to back (steel)

5  
S

KITPA

## Impero

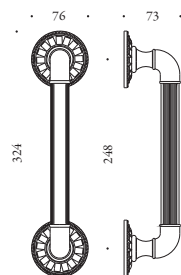

Maniglione dritto completo  
di accessori per il fissaggio  
passante singolo  
con copridadi interni.  
Straight pull handle complete with  
single through fixing accessories  
and internal bolts.

**i** Per la versione passante accoppiato  
verrà fornito in abbinamento,  
solo su ordinazione,  
l'articolo KIM16PA.  
For back to back version the article  
KIM16PA will be supplied  
for coupling orders only.

INT  
248  
1  
S

KIM16

● ON  
● BR  
● AG

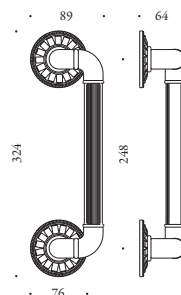

Maniglione zancato completo di  
accessori per il fissaggio  
passante singolo  
con copridadi interni.  
Off set pull handle complete with  
single through fixing accessories  
and internal bolts.

**i** Per la versione passante accoppiato  
verrà fornito in abbinamento,  
solo su ordinazione,  
l'articolo KIM26PA.  
For back to back version the article  
KIM26PA will be supplied  
for coupling orders only.

INT  
248  
1  
S

KIM26

● ON  
● BR  
● AG



**Capri KCR26**  
BR Bronzo non verniciato  
Bronze not lacquered



**Capri KCR16**  
ON Ottone naturale non verniciato  
Natural brass not lacquered



**Impero KIM16**  
ON Ottone naturale non verniciato  
Natural brass not lacquered

**Impero KIM26**  
ON Ottone naturale non verniciato  
Natural brass not lacquered



Louis XVI		<p>Maniglione dritto completo di accessori per il fissaggio non passante (con viti a vista). Straight pull handle complete with surface fixing kit (with exposed screws).</p>	INT 175 1 S	<b>KLU16NP</b>	ON BR AG
		<p>Maniglione zancato completo di accessori per il fissaggio non passante (con viti a vista). Off set pull handle complete with surface fixing kit (with exposed screws).</p>	INT 175 1 S	<b>KLU26NP</b>	ON BR AG
		<p>Maniglione dritto completo di accessori per il fissaggio passante singolo con copridadi interni. Straight pull handle complete with single through fixing accessories and internal bolts.</p>	INT 175 1 S	<b>KLU16PS</b>	ON BR AG
		<p>Maniglione dritto completo di accessori per il fissaggio passante singolo con copridadi interni. Off set pull handle complete with single through fixing accessories and internal bolts.</p>	INT 175 1 S	<b>KLU26PS</b>	ON BR AG





**Louis XVI KLU16**  
ON Ottone naturale non verniciato  
Natural brass not lacquered



**Louis XVI KLU26**  
ON Ottone naturale non verniciato  
Natural brass not lacquered

Ottocento		<p>Maniglione diritto completo di accessori per il fissaggio passante singolo con copridadi interni e per il fissaggio non passante. Straight pull handle complete with single through fixing accessories and internal bolts, and surface fixing kit.</p>	<p>INT 220</p> <p>1 S</p>	KOT16	<p>● ON</p> <p>● BR</p> <p>● AG</p> <p>● NI</p>
		<p>Maniglione zancato completo di accessori per il fissaggio passante singolo con copridadi interni e per il fissaggio non passante. Off set pull handle complete with single through fixing accessories and internal bolts, and surface fixing kit.</p>	<p>INT 220</p> <p>1 S</p>	KOT26	<p>● ON</p> <p>● BR</p> <p>● AG</p> <p>● NI</p>
Venezia		<p>Maniglione diritto privo di kit di fissaggio PS e PA da acquistare separatamente Straight pull handle. Pulls price with PS and PA fixing kit NOT included to be purchased separately.</p>	<p>INT 200</p> <p>1 S</p>	KVE16	<p>● ON</p> <p>● BR</p>
		<p> KIT PS Passante Singolo (acciaio-ottone) Single pull-bolt through (steel-brass)</p>	<p>5 S</p>	KITPS	<p>● ON</p> <p>● BR</p>
		<p> KIT PA Passante Accoppiato (acciaio) Back to back (steel)</p>	<p>5 S</p>	KITPA	
Venezia		<p>Maniglione diritto privo di kit di fissaggio PS e PA da acquistare separatamente Straight pull handle. Pulls price with PS and PA fixing kit NOT included to be purchased separately.</p>	<p>INT 300</p> <p>1 S</p>	KVE26	<p>● ON</p> <p>● BR</p>
		<p> KIT PS Passante Singolo (acciaio-ottone) Single pull-bolt through (steel-brass)</p>	<p>5 S</p>	KITPS	<p>● ON</p> <p>● BR</p>
		<p> KIT PA Passante Accoppiato (acciaio) Back to back (steel)</p>	<p>5 S</p>	KITPA	
Vitto		<p>Maniglione diritto completo di accessori per il fissaggio passante singolo con copridadi interni. Off set pull handle complete with single through fixing accessories and internal bolts.</p>	<p>INT 105</p> <p>1 S</p>	KOT36	<p>● ON</p> <p>● BR</p>



**Ottocento KOT16**  
ON Ottone naturale non verniciato  
Natural brass not lacquered



**Ottocento KOT26**  
ON Ottone naturale non verniciato  
Natural brass not lacquered

**Venezia KVE16**  
BR Bronzo non verniciato  
Bronze not lacquered



**Venezia KVE26**  
ON Ottone naturale non verniciato  
Natural brass not lacquered



**Vitto KOT36**  
BR Bronzo non verniciato  
Bronze not lacquered

# Maniglioni per alzante scorrevole *Pull-up handles for sliding door*

materiale: ottone  
material: brass

<p><i>Busiri</i></p>		<p>Maniglione per alzante scorrevole completo di maniglia ad incasso. Pull-up handle for sliding door complete with flush handle.</p>		<p><b>KBU113</b></p>	<p>● ON ● BR ● AG</p>	
<p><i>Impero</i></p>		<p>Maniglione per alzante scorrevole completo di maniglia ad incasso. Pull-up handle for sliding door complete with flush handle.</p>		<p><b>KIM113</b></p>	<p>● ON ● BR ● AG</p>	
<p><i>Louis XVI</i></p>		<p>Maniglione per alzante scorrevole completo di maniglia ad incasso. Pull-up handle for sliding door complete with flush handle.</p>		<p><b>KLU113</b></p>	<p>● ON ● BR ● AG</p>	

# *Maniglioni per alzante scorrevole* Pull-up handles for sliding door







**Busiri KBU113**  
ON Ottone naturale non verniciato  
Natural brass not lacquered



**Impero KIM113**  
ON Ottone naturale non verniciato  
Natural brass not lacquered

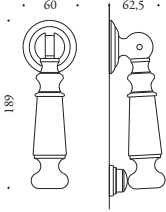

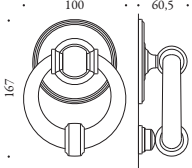
**Louis XVI KLU113**  
ON Ottone naturale non verniciato  
Natural brass not lacquered

Ottocento		<p>Battiporta completo di accessori per il fissaggio passante con copridado interno. Door knocker complete with through fixing accessories and internal bolt.</p>		<b>KOT115</b>	
		<p>Battiporta completo di accessori per il fissaggio passante con copridado interno. Door knocker complete with through fixing accessories and internal bolt.</p>		<b>KOT215</b>	



**Ottocento KOT115**  
**ON** Ottone naturale non verniciato  
Natural brass not lacquered









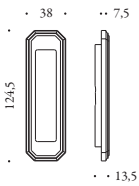

**Ottocento KOT215**  
**BR** Bronzo non verniciato  
Bronze not lacquered

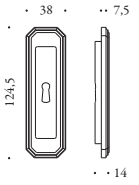

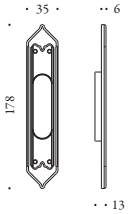

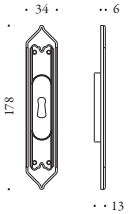
*Maniglie  
incasso*  
*Flush handles*

<i>Busiri</i>		<p>Maniglia incasso con fissaggio con chiodino. Flush handle fixed with nail.</p>		<p><b>KBU111</b></p>	<p>● ON ● BR ● AG ● CR</p>
		<p>Maniglia incasso con foro chiave e fissaggio con chiodino. Flush handle with key hole and fixed with nail.</p>		<p><b>KBU111CF</b></p>	<p>● ON ● BR ● AG ● CR</p>
<i>Louis XVI</i>		<p>Maniglia incasso con fissaggio viti a vista. Flush handle fixed with exposed screws.</p>		<p><b>KLU111</b></p>	<p>● ON ● BR ● AG</p>
		<p>Maniglia incasso con foro chiave e fissaggio viti a vista. Flush handle with key hole and fixed with exposed screws.</p>		<p><b>KLU111CF</b></p>	<p>● ON ● BR ● AG</p>

# Maniglie incasso *Flush handles*



**Busiri KBU111**  
ON Ottone naturale non verniciato  
Natural brass not lacquered



**Busiri KBU111CF**  
BR Bronzo non verniciato  
Bronze not lacquered



**Louis XVI KLU111CF**  
AG Argento naturale non verniciato  
Natural silver not lacquered



**Louis XVI KLU111**  
BR Bronzo non verniciato  
Bronze not lacquered

# Maniglie incasso *Flush handles*

materiale: ottone  
material: brass

Ottocento		<p>Maniglia incasso con fissaggio con chiodino. Flush handle fixed with nail.</p>		<p><b>KOT111</b></p>	<ul style="list-style-type: none"> <li><span style="display: inline-block; width: 10px; height: 10px; background-color: yellow; border-radius: 50%; margin-right: 5px;"></span> ON</li> <li><span style="display: inline-block; width: 10px; height: 10px; background-color: brown; border-radius: 50%; margin-right: 5px;"></span> BR</li> <li><span style="display: inline-block; width: 10px; height: 10px; background-color: lightgray; border-radius: 50%; margin-right: 5px;"></span> AG</li> <li><span style="display: inline-block; width: 10px; height: 10px; background-color: gray; border-radius: 50%; margin-right: 5px;"></span> NI</li> </ul>
		<p>Maniglia incasso con foro chiave e fissaggio con chiodino. Flush handle with key hole and fixed with nail.</p>		<p><b>KOT111CF</b></p>	<ul style="list-style-type: none"> <li><span style="display: inline-block; width: 10px; height: 10px; background-color: yellow; border-radius: 50%; margin-right: 5px;"></span> ON</li> <li><span style="display: inline-block; width: 10px; height: 10px; background-color: brown; border-radius: 50%; margin-right: 5px;"></span> BR</li> <li><span style="display: inline-block; width: 10px; height: 10px; background-color: lightgray; border-radius: 50%; margin-right: 5px;"></span> AG</li> <li><span style="display: inline-block; width: 10px; height: 10px; background-color: gray; border-radius: 50%; margin-right: 5px;"></span> NI</li> </ul>

# *Maniglie incasso* Flush handles













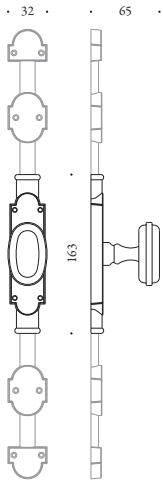



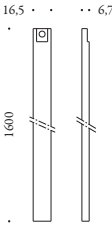



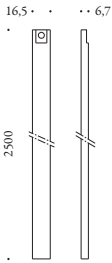

**Ottocento KOT111**  
**BR** Bronzo non verniciato  
Bronze not lacquered

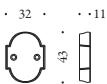

**Ottocento KOT111CF**  
**NI** Nichel naturale non verniciato  
Natural nickel not lacquered



*Complementi*  
*Complements*

Ottocento		<p>Cremonese per aste esterne completa di movimento MP Window handle MP mechanism for external rods</p> <p> Istruzione montaggio a pag. 144 Mounting instruction at page 144</p>		<p><b>KOT22AV</b></p>	<p> ON  BR</p>
		<p>Asta esterna in ottone 6,7x16,5x1600 mm per cremonese art. KOT22AV External rod in brass 6,7x16,5x1600mm for window handle art. KOT22AV</p>		<p><b>KOT22A0160</b></p>	<p> ON  BR</p>
		<p>Asta esterna in ottone 6,7x16,5x2500 mm per cremonese art. KOT22AV External rod in brass 6,7x16,5x2500mm for window handle art. KOT22AV</p>		<p><b>KOT22A0250</b></p>	<p> ON  BR</p>
		<p>Passante ovale per asta Oval loop fitting for rod</p>		<p><b>KOT22PS</b></p>	<p> ON  BR</p>
		<p>Terminale ovale per asta. Oval final fitting for rod.</p> <p> Solo su richiesta si fornisce il terminale per asta a "sbalzo" Available on request the final fitting for rod is furnished</p>		<p><b>KOT22TO</b></p>	<p> ON  BR</p>



# Cremonese per aste esterne Window handle for external rods

**Ottocento KOT22AV**  
ON Ottone naturale non verniciato  
Natural brass not lacquered



**Ottocento KOT22A0**  
ON Ottone naturale non verniciato  
Natural brass not lacquered









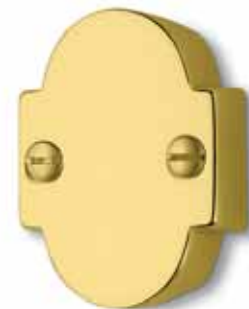

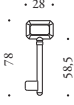





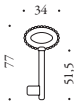



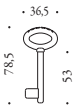



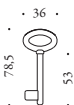

**Ottocento KOT22T0**  
ON Ottone naturale non verniciato  
Natural brass not lacquered



**Ottocento KOT22PS**  
ON Ottone naturale non verniciato  
Natural brass not lacquered



<p><i>Busiri</i></p>		<p>Chiave Key</p>		<p><b>KBU14</b></p>	<ul style="list-style-type: none"> <li> ON</li> <li> BR</li> <li> AG</li> <li> CR</li> </ul>	
<p><i>Impero</i></p>		<p>Chiave Key</p>		<p><b>KIM14</b></p>	<ul style="list-style-type: none"> <li> ON</li> <li> BR</li> <li> AG</li> </ul>	
<p><i>Impero</i></p>		<p>Chiave Key</p>		<p><b>KIM24</b></p>	<ul style="list-style-type: none"> <li> ON</li> <li> BR</li> <li> AG</li> </ul>	
<p><i>Louis XVI</i></p>		<p>Chiave Key</p>		<p><b>KLU14</b></p>	<ul style="list-style-type: none"> <li> ON</li> <li> BR</li> <li> AG</li> </ul>	
<p><i>Settecento</i></p>		<p>Chiave Key</p>		<p><b>KSE14</b></p>	<ul style="list-style-type: none"> <li> ON</li> <li> BR</li> <li> AG</li> <li> NI</li> </ul>	

**Busiri KBU14**

**ON** Ottone naturale non verniciato  
Natural brass not lacquered



**Impero KIM24**

**ON** Ottone naturale non verniciato  
Natural brass not lacquered



**Impero KIM14**

**ON** Ottone naturale non verniciato  
Natural brass not lacquered



**Louis XVI KLU14**









**ON** Ottone naturale non verniciato  
Natural brass not lacquered



**Settecento KSE14**

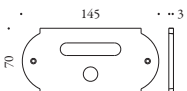







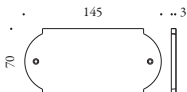

**ON** Ottone naturale non verniciato  
Natural brass not lacquered

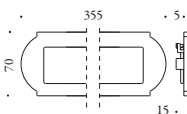

Ottocento		<p>Campanello su piastrina piccola completo di tasto con parte elettrica e accessori per il fissaggio Door bell with small plate complete with electrical button and accessories for fixing</p>	 	<b>KOT418</b>	 <b>ON</b>  <b>BR</b>	
		<p>Campanello su piastra con fessura portanome completo di tasto con parte elettrica e accessori per il fissaggio Door bell on plate with name holder, electrical button and accessories for fixing</p>	 	<b>KOT318</b>	 <b>ON</b>  <b>BR</b>	

 Finiture verniciate disponibili su richiesta (vedi 2a di copertina)  
Lacquered finishes available on request (see back cover)

# Targhetta e buca per lettere *Name and letter plate*

Ottocento		<p>Targa liscia completa di accessori per il fissaggio Door plate complete of accessories for fixing</p>	 	<b>KOT118</b>	 <b>ON</b>  <b>BR</b>	
		<p>Buca per lettere completa di accessori per il fissaggio. Foro 270x35mm Mail holder complete of accessories for fixing. Hole 270x35mm</p> <p> Istruzioni montaggio a pag. 144 Mounting instructions at page 144</p>	 	<b>KOT218</b>	 <b>ON</b>  <b>BR</b>	

 Finiture verniciate disponibili su richiesta (vedi 2a di copertina)  
Lacquered finishes available on request (see back cover)

# Campanelli, targhetta e buca per lettere *Door bells, name and letter plate*



**Ottocento KOT418**  
ON Ottone naturale non verniciato  
Natural brass not lacquered













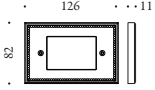





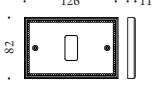





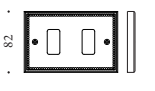





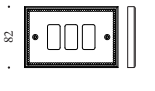





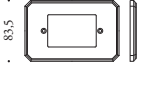





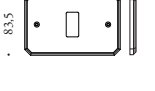





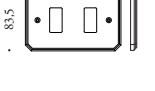

**Ottocento KOT318**  
ON Ottone naturale non verniciato  
Natural brass not lacquered

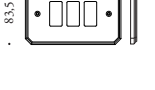

**Ottocento KOT118**  
ON Ottone naturale non verniciato  
Natural brass not lacquered



**Ottocento KOT218**  
ON Ottone naturale non verniciato  
Natural brass not lacquered

<b>Louis XVI</b>		L.L. = Living Light M.TT = Magic TT VI = Vimar Idea  In fase d'ordine specificare la tipologia when ordering, please specify the typology		<b>KLU18/A L.L.</b> <b>KLU18/A M.TT</b> <b>KLU18/A VI</b>	 ON  BR  AG  CR
		Magic tipo A (un foro) Magic, A type (one hole)		<b>KLU18/A MAGIC</b>	 ON  BR  AG  CR
		Magic tipo B (due fori) Magic, B type (two holes)		<b>KLU18/B MAGIC</b>	 ON  BR  AG  CR
		Magic tipo C (tre fori) Magic, C type (three holes)		<b>KLU18/C MAGIC</b>	 ON  BR  AG  CR
<b>Ottocento</b>		L.L. = Living Light M.TT = Magic TT VI = Vimar Idea  In fase d'ordine specificare la tipologia when ordering, please specify the typology		<b>KOT18/A L.L.</b> <b>KOT18/A M.TT</b> <b>KOT18/A VI</b>	 ON  BR  AG  CR
		Magic tipo A (un foro) Magic, A type (one hole)		<b>KOT18/A MAGIC</b>	 ON  BR  AG  CR
		Magic tipo B (due fori) Magic, B type (two holes)		<b>KOT18/B MAGIC</b>	 ON  BR  AG  CR
		Magic tipo C (tre fori) Magic, C type (three holes)		<b>KOT18/C MAGIC</b>	 ON  BR  AG  CR

# *Coprinterruttori* Switch plates









**Louis XVI KLU18**  
ON Ottone naturale non verniciato  
Natural brass not lacquered

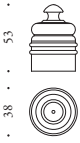

**Ottocento KOT18**  
BR Bronzo non verniciato  
Bronze not lacquered

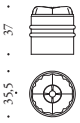
# Fermaporta *Door stoppers*









materiale: ottone  
material: brass

<p><i>Byblos</i></p>		<p>Fermaporta Door stopper</p>		<p><b>KBY112</b></p>	<p> <b>OLV</b>  <b>BSV</b></p>	
<p><i>Universal</i></p>		<p>Fermaporta universale Universal door stopper</p>		<p><b>KUN112</b></p>	<p> <b>ON</b>  <b>BR</b></p>	

 Finiture verniciate disponibili su richiesta (vedi 2a di copertina)  
Lacquered finishes available on request (see back cover)

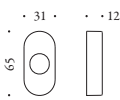
# Copridado e rosetta per DK *Bold and DK rose*

materiale: ottone  
material: brass

<p><i>kdado</i></p>		<p>Copridado completo di viti per il fissaggio Bolt complete with fixing screws</p>		<p><b>KDADO</b></p>	<p> <b>ON</b>  <b>BR</b>  <b>AG</b></p>	
<p><i>krosdk</i></p>		<p>Rosetta per Dreh-Kipp Dreh-Kipp rose</p>		<p><b>KROSDK</b></p>	<p> <b>ON</b>  <b>BR</b></p>	

 Finiture verniciate disponibili su richiesta (vedi 2a di copertina)  
Lacquered finishes available on request (see back cover)





***Byblos KBY112***  
ON Ottone naturale non verniciato  
Natural brass not lacquered











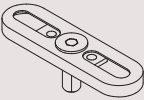
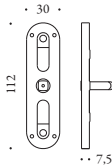

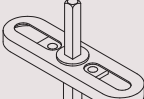
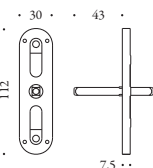

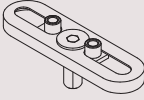
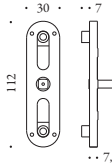

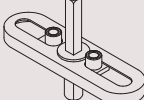
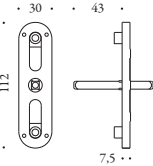

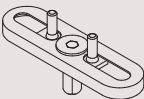
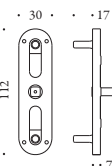

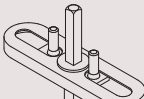
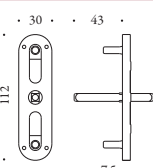

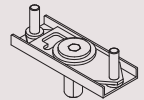
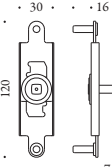
***Universal KUN112***  
ON Ottone naturale non verniciato  
Natural brass not lacquered

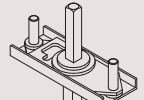
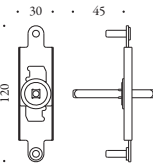

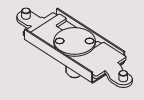
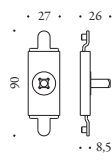

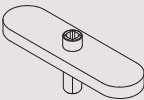
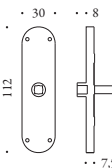





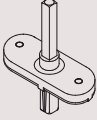
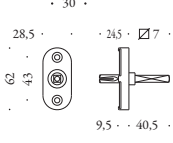

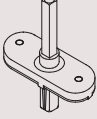
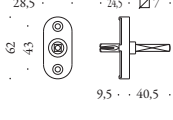

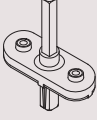
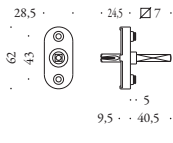

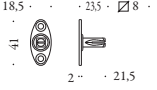
*Accessori*  
*Accessories*

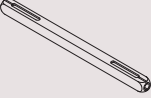
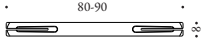

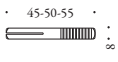







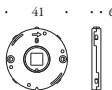



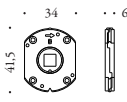

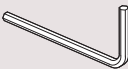
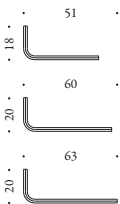
# Movimenti *Movements*

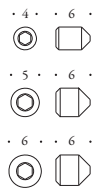
		Movimento GRATZ GRATZ movement			<b>KGRATZ</b>	Acciaio Steel	
		Movimento GRATZ-7 GRATZ-7 movement			<b>KGRATZ-7</b>	Acciaio Steel	
		Movimento GRATZ con boccole GRATZ movement with nips			<b>KGRATZ-CB</b>	Acciaio Steel	
		Movimento GRATZ-7 con boccole GRATZ-7 movement with nips			<b>KGRATZ-7CB</b>	Acciaio Steel	
		Movimento GRATZ con perni GRATZ movement with pivots			<b>KGRATZ-CP</b>	Acciaio Steel	
		Movimento GRATZ-7 con perni GRATZ-7 movement with pivots			<b>KGRATZ-7CP</b>	Acciaio Steel	
		Movimento MP MP movement			<b>KMP</b>	Acciaio Steel	
		Movimento MP-7 MP-7 movement			<b>KMP-7</b>	Acciaio Steel	
		Movimento MP-7 per KOT22AV MP-7 movement for KOT22AV			<b>KMP/AV</b>	Acciaio Steel	
		Movimento GUERRIERO GUERRIERO movement			<b>KGUERRIERO</b>	Acciaio Steel	

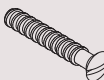
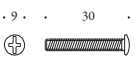



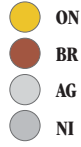
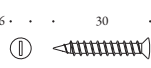

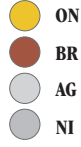

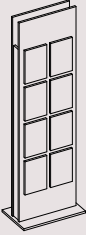
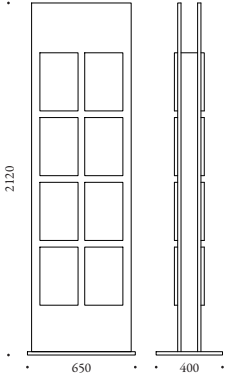

# Movimenti e Quadri *Movements and Spindles*

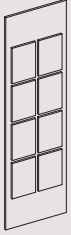
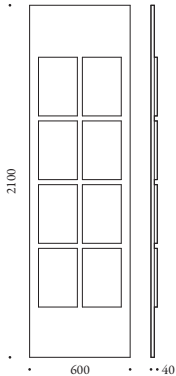
		DK 40 senza scatti Leverage without stops		<b>KDK</b>	Acciaio Steel	
		DK 40 senza boccole - 4 scatti Leverage 4 stops without axles		<b>KDK-40</b>	Acciaio Steel	
		DK 40D con boccole Ø10 - 4 scatti Leverage 4 stops with Ø10 axles		<b>KDK40D</b>	Acciaio Steel	
		Dummy 20 non passante, quadro 8mm fisso. Possibilità di montaggio su rosetta "R" 20mm Dummy (not trough passing) 8mm spindle. Suitable for Rose "R"		<b>KDUMMY</b>	Acciaio Steel	
		Quadri 8x8x80 - 8x8x90 8x8x80 - 8x8x90 spindles		<b>KQUADRO80</b> <b>KQUADRO90</b>	Acciaio Steel	
		Quadri 8x8x45 - 8x8x50 - 8x8x55 8x8x45 - 8x8x50 - 8x8x55 spindles		<b>KQUADROBLK45</b> <b>KQUADROBLK50</b> <b>KQUADROBLK55</b>	Acciaio Steel	
		Quadri 7x7x65 - 7x7x70 7x7x65 - 7x7x70 spindles		<b>KQUADROM7-65</b> <b>KQUADROM7-70</b>	Acciaio Steel	

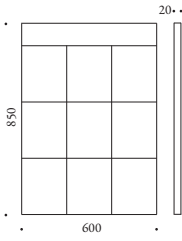
# Molle e Ferramenta *Springs and Hardware*

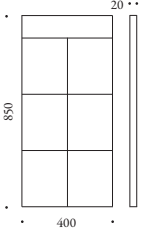
		Molla per rosetta Ø45mm Spring cassette for rose Ø45mm			<b>KMOLLA</b>	
		Molla per placca maniglia Busiri Spring cassette for Busiri handle			<b>KMOLLA PL</b>	
		CHIAVE esagonale da 2 - 2,5 - 3 2 - 2,5 - 3 exagonal key			<b>KCHIAVE2 KCHIAVE2,5 KCHIAVE3</b>	Acciaio Steel
		GRANO M4x6 nikelato per porta M4x6 door grub screw  GRANO M5x6 nikelato per finestra M5x6 window grub screw  GRANO M6x6 eslock (x Art. KIM16 . KIM26) M6x6 eslock grub screw (x Art. KIM16 . KIM26)			<b>KGRANO4X6 KGRANO5X6 KGRANO6X6</b>	Acciaio Steel
		VITE M4x30 zincata solo per pomolini mobile (KAC119 . KLU119 . KIM119) M4x30 galvanize screw only for furniture knobs (KAC119 . KLU119 . KIM119)			<b>KVITE4X30</b>	Acciaio Steel
		VITE 3x16 TGST VITE 3x20 TGST VITE 3x25 TGST VITE 3x30 TGST in ottone 3x16 TGST brass screw 3x20 TGST brass screw 3x25 TGST brass screw 3x30 TGST brass screw			<b>KVITE3X16 KVITE3X20 KVITE3X25 KVITE3X30</b>	
		VITE 3,5x30 TGST in ottone (KLU16NP . KLU26NP) 3,5x30 TGST brass screw (KLU16NP . KLU26NP)			<b>KVITE3.5</b>	

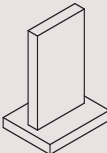
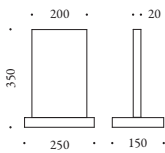
*Espositori*  
*Display boards*

		<p>Espositore bifacciale Colori: frassino con fondo bianco Double face board ash wood and white background</p> <p><b>i</b> Tutti i singoli pannelli sono asportabili ed intercambiabili all the panels are interchangeable</p>		<p><b>KESP/BSB</b></p>	<p>Legno Wood</p>	
		<p>Pannello monofacciale Colori: frassino con fondo bianco single face board ash wood and white background</p>		<p><b>KESP/BSP</b></p>	<p>Legno Wood</p>	
		<p>Pannello bisellato monofacciale Colori: frassino con testata bianca Single face board ash wood and white crowner</p>		<p><b>KPANNELLO9</b></p>	<p>Legno Wood</p>	
		<p>Pannello bisellato monofacciale Colori: frassino con testata bianca Single face board ash wood and white crowner</p>		<p><b>KPANNELLO6</b></p>	<p>Legno Wood</p>	
		<p>Pannello da banco Colore base: bianco Colore montante: frassino desk display mount ash wood and white base</p>		<p><b>KESP.BANCO</b></p>	<p>Legno Wood</p>	



*Dati tecnici*  
*Technical datas*

# dimensioni placche per porta

door plate sizes

**i** le misure riportate sono indicative ed espresse in millimetri  
the measures mentioned are not binding and are stated in millimetres

**A** misura altezza totale della placca  
total plate length

**B** misura larghezza totale della placca  
total plate width



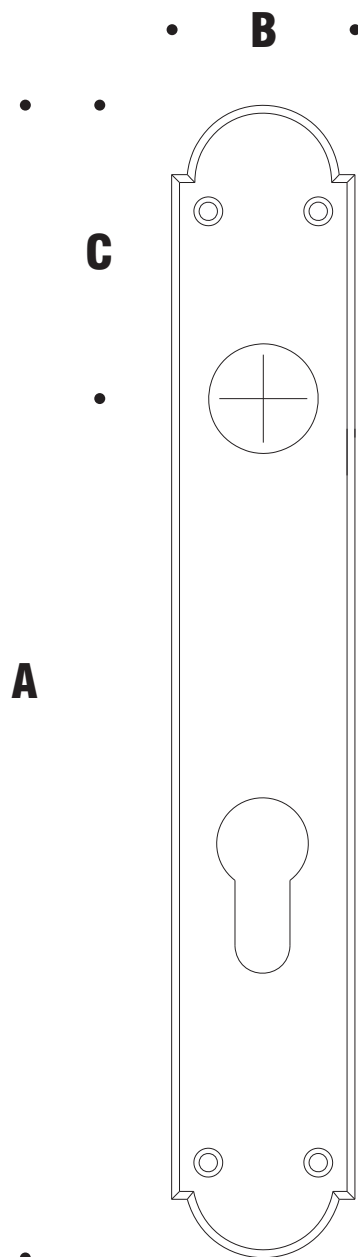





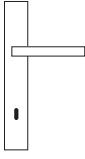

**C** misura dal centro del foro dell'impugnatura al filo superiore della placca  
spacing between handle hole and upper point

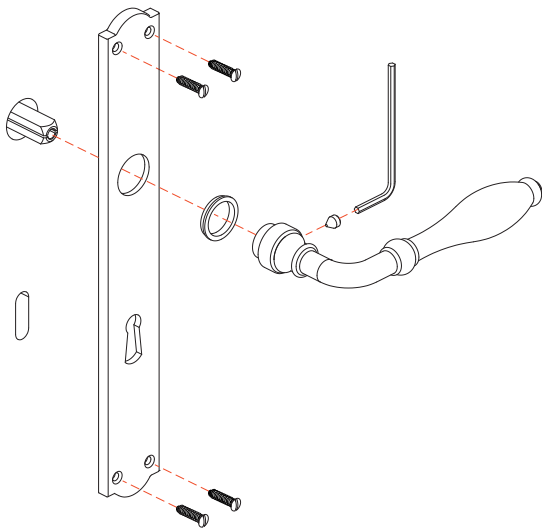
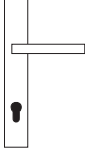

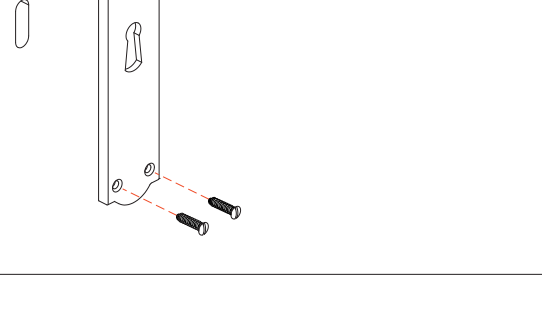
MANIGLIE HANDLES	ARTICOLO ARTICLE	A	B	C	MATERIALE MATERIAL
<i>accademia</i>	KAC11PB	220	35	72,5	OTTONE . BRASS
	KAC11PBY				
	KAC11PBX	240	40	75	
	KAC11PBYX				
<i>barocco</i>	KBA11P	289	40	99,5	OTTONE . BRASS
	KBA11PY				
<i>bellagio</i>	KBE11PB	230	35	70	OTTONE . BRASS
	KBE11PBY				
<i>busiri</i>	KBU11P	238	45	75	OTTONE . BRASS
	KBU11PY				
<i>byblos</i>	KBY11P	345	59	120	OTTONE . BRASS
	KBY11PY				
<i>firenze</i>	KOT21PB	205	30	60	OTTONE . BRASS
	KOT21PBY				
<i>impero</i>	KIM11PB	254	37	75	OTTONE . BRASS
	KIM11PBY				
<i>lidia</i>	KOT31P	242	40	75	OTTONE . BRASS
	KOT31PY				
<i>louis XVI</i>	KLU11PB	254	37	75	OTTONE . BRASS
	KLU11PBY				
<i>ottocento</i>	KOT11PB	220	35	72,5	OTTONE . BRASS
	KOT11PBY				
	KOT11PBX	240	40	75	
	KOT11PBYX				
<i>palatino</i>	KPA11PB	228	32	75	OTTONE . BRASS
	KPA11PBY				
<i>roma</i>	KSE21PB	255	40	77,5	OTTONE . BRASS
	KSE21PBY				
<i>settecento</i>	KSE11PB	220	35	72,5	OTTONE . BRASS
	KSE11PBY				
	KSE11PBX	240	40	75	
	KSE11PBYX				
<i>siena</i>	KSI11PB	225	32	75	OTTONE . BRASS
	KSI11PBY				

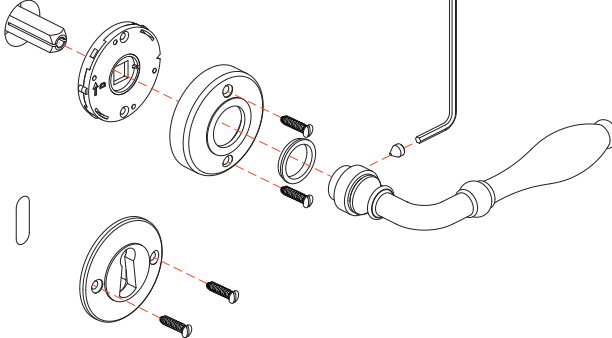
# sistema di montaggio maniglie per porta

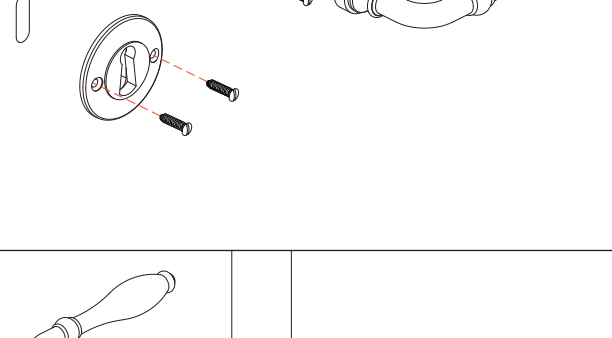
door handles mounting system

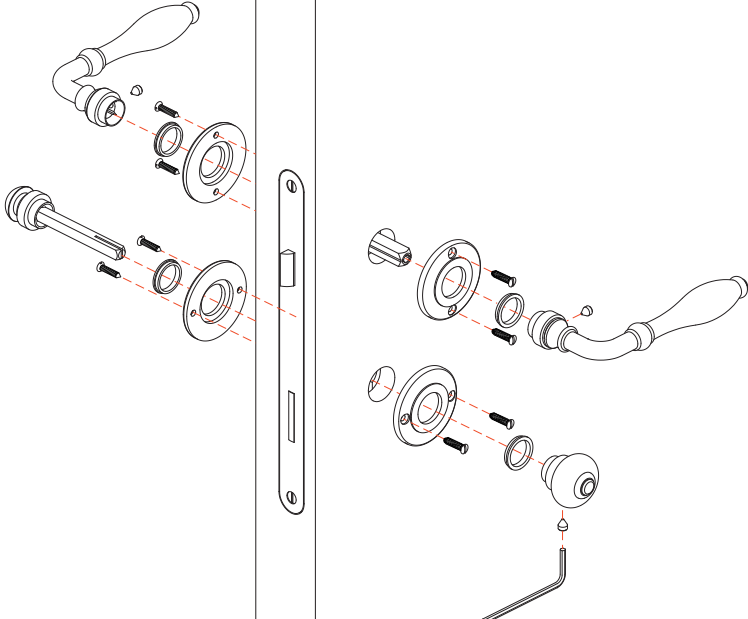
TIPOLOGIA DESCRIPTION	ESPLOSO TECNICO TECHNICAL DETAILS	
<p><b>PB</b></p> 		
<p><b>PBY</b></p> 		
<p><b>R</b></p> 		
<p><b>RY</b></p> 		
<p><b>BZG</b></p> 		

# sistema di montaggio maniglie per finestra

windows handles mounting system

TIPOLOGIA DESCRIPTION

ESPLOSO TECNICO TECHNICAL DETAILS

**M**



**IM**



**DK/SM**

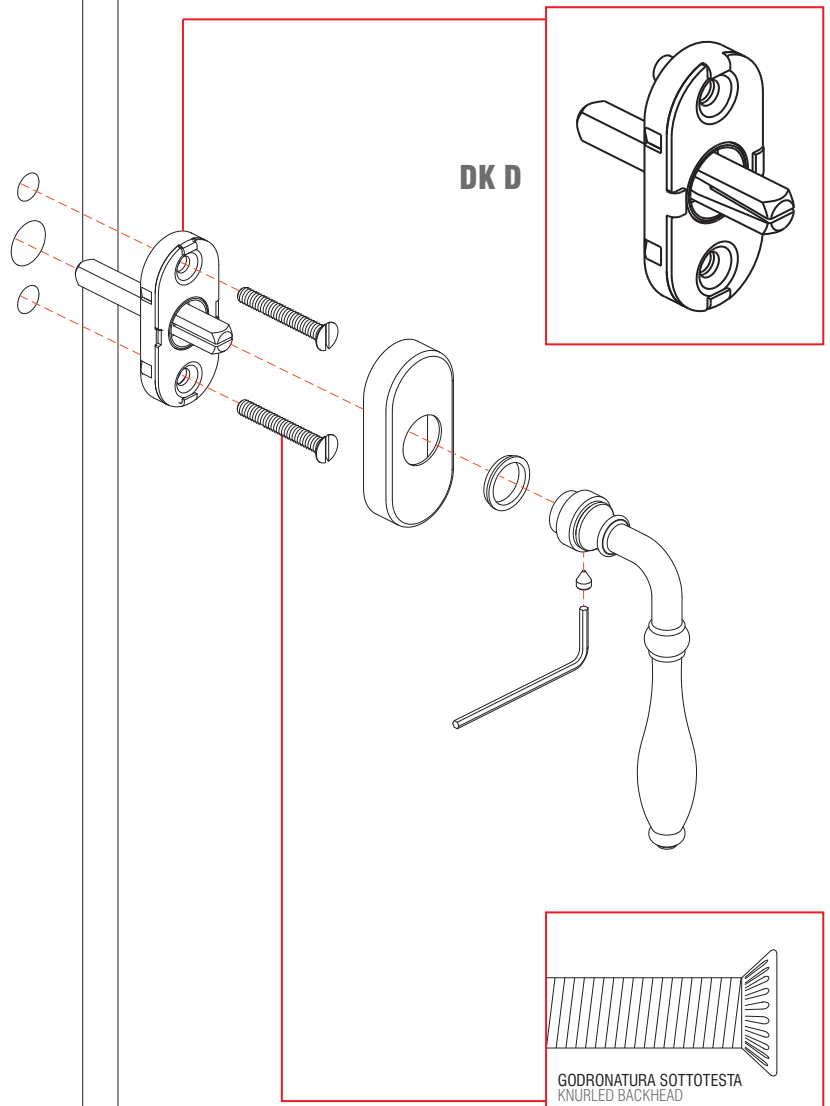
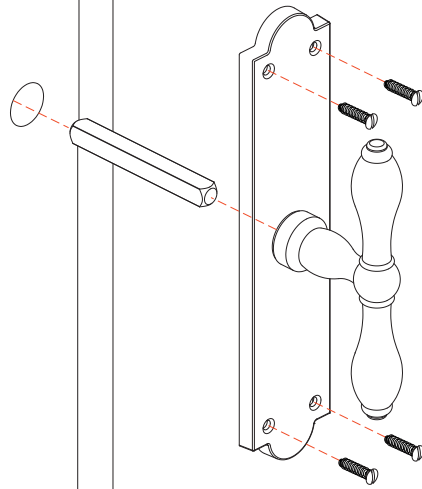

# sistema di montaggio pomoli fissi

fixed knobs mounting system

**KBU25 FISSO 70x70**  
PASSANTE SINGOLO BOLT THROUGH FIXING

busiri

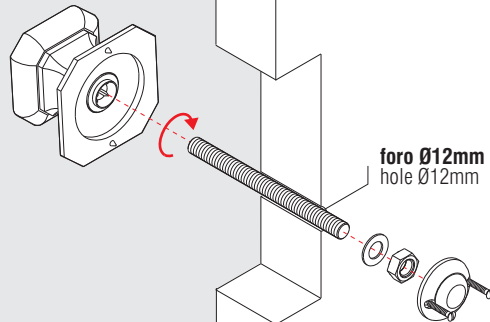
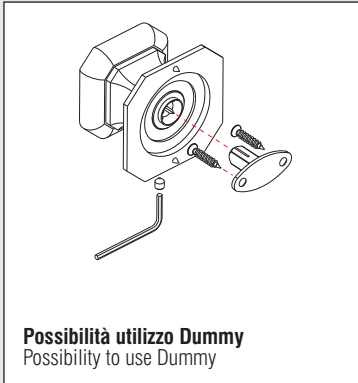

**KBU35 FISSO 110x110**  
PASSANTE SINGOLO BOLT THROUGH FIXING

busiri

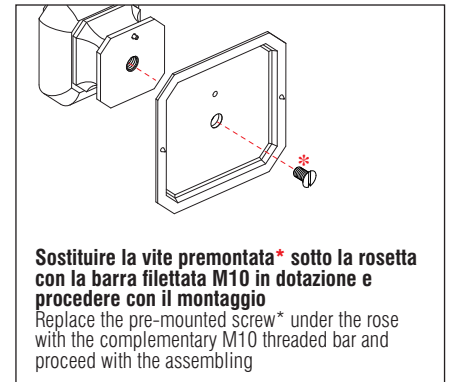
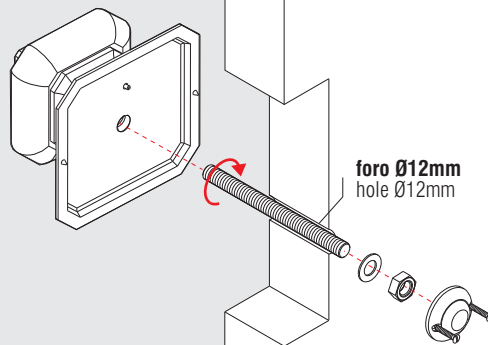
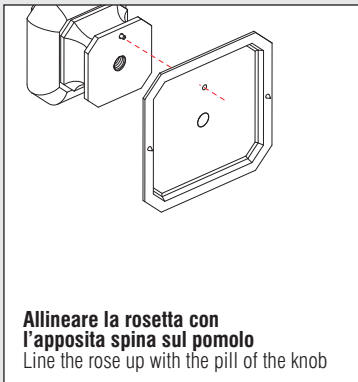

**KBY15 FISSO Ø120 KBY25 FISSO Ø120 KD015 FISSO Ø119,5**  
PASSANTE SINGOLO BOLT THROUGH FIXING

byblos - doge

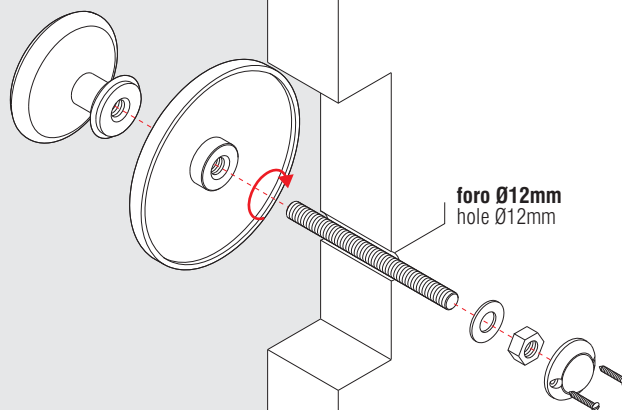

# sistemi di montaggio maniglioni

*pulls mounting system*

## NON PASSANTE SINGLE FACE FIXING

**KBU26NP** busiri

**KBY16NP-KBY26NP** byblos

**KLU16NP - KLU26NP** louis XVI

**KOT16-KOT26** ottocento

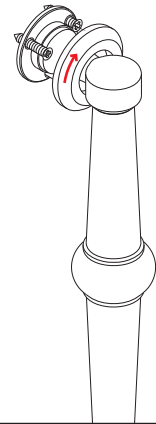
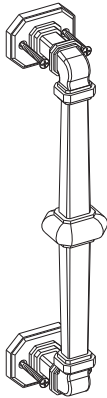

## PASSANTE SINGOLO BOLT THROUGH FIXING

**KBU16** busiri

**KBU26PS** busiri

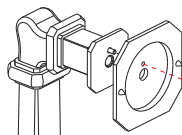
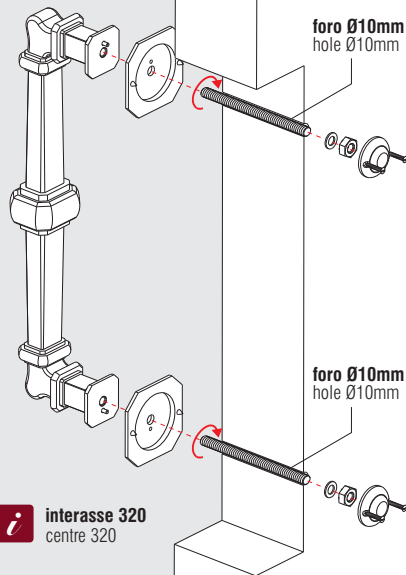

**Allineare le rosette con le apposite spine sui maniglioni**  
Line the roses up with the pills of the pulls

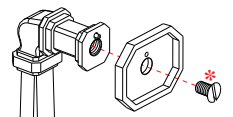
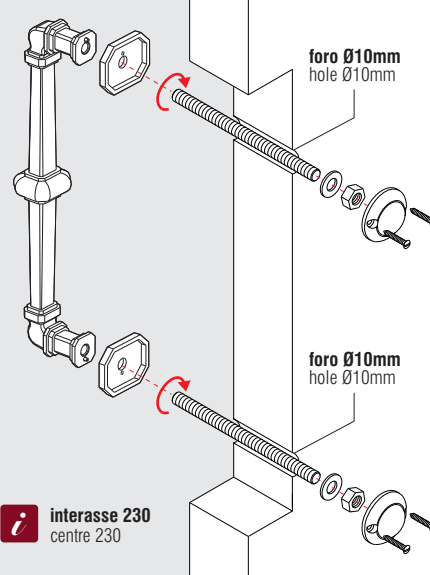

**Sostituire le viti premontate\* sotto le rosette del KBU26PS con le barre filettate M8 in dotazione e procedere con il montaggio**  
Replace the pre-mounted screws\* under the KBU26PS roses with the complementary threaded bars M8 and proceed with the assembling

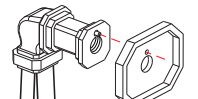

**Allineare le rosette con le apposite spine sui maniglioni**  
Line the roses up with the pills of the pulls

**KBA16** barocco

**KBY16-KBY26** byblos

**KCR16-KCR26** capri

**KVE16-KVE26** venezia

**KBA16 - interasse 250**  
KBA16 - centre 250

**KBY16 - interasse 220**  
KBY16 - centre 220

**KBY26 - interasse 300**  
KBY26 - centre 300

**KCR16 - interasse 200**  
KVE16 - centre 200

**KCR26 - interasse 300**  
KVE26 - centre 300

**KVE16 - interasse 200**  
KVE16 - centre 200

**KVE26 - interasse 300**  
KVE26 - centre 300

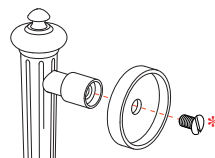
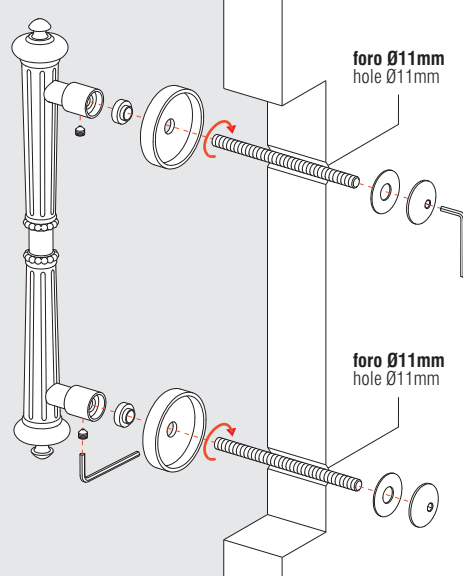

**Sostituire le viti premontate\* con le barre filettate M8**  
Replace the pre-mounted screws with the M8 threaded bars

# sistema di montaggio maniglioni

*pulls mounting system*

## PASSANTE SINGOLO BOLT THROUGH FIXING

### KIM16-KIM26 *impero*

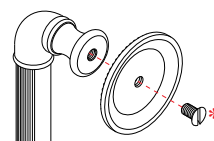
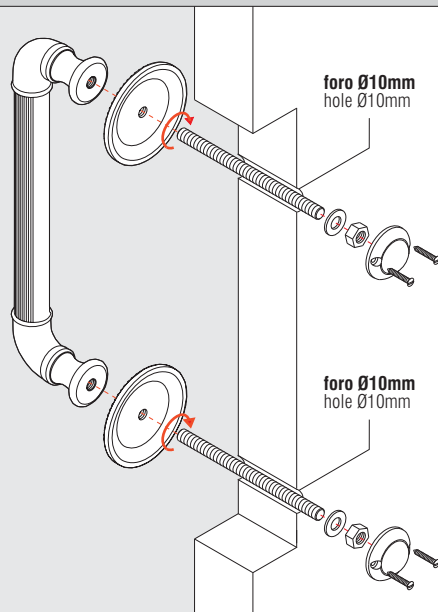

**Sostituire le viti premontate\* con le barre filettate M8**  
 Replace the pre-mounted screws with the M8 threaded bars

**i** interasse 248  
 centre 248

### KLU16PS-KLU26PS *louis XVI*

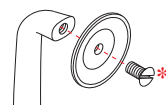
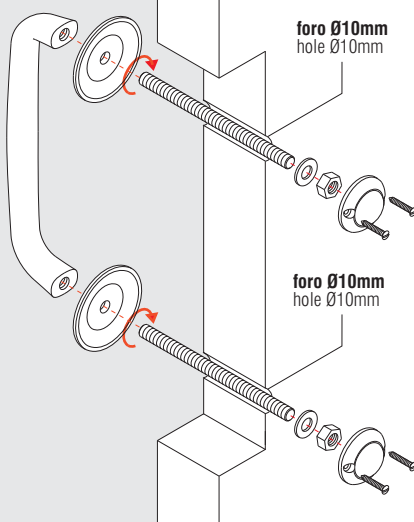

**Sostituire le viti premontate\* con le barre filettate M8**  
 Replace the pre-mounted screws with the M8 threaded bars

**i** interasse 175  
 centre 175

### KOT16-KOT26 *ottocento*

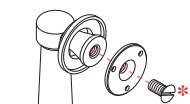
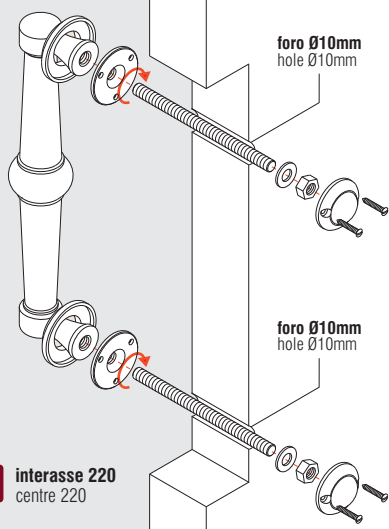

**Sostituire le viti premontate\* con le barre filettate M8**  
 Replace the pre-mounted screws with the M8 threaded bars

**i** interasse 220  
 centre 220

### KOT36 *vitto*

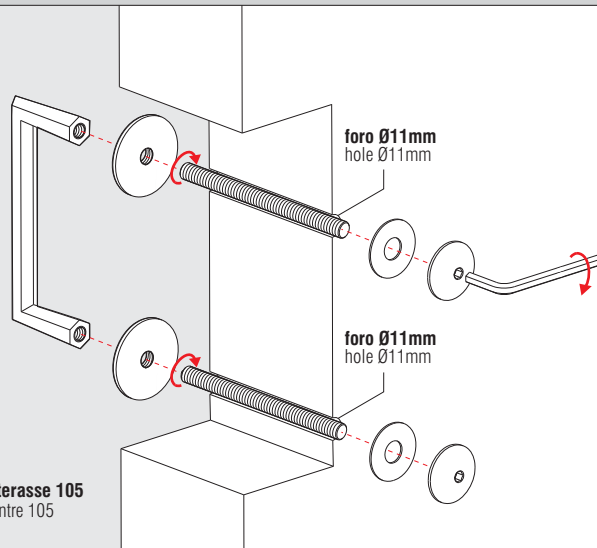

**i** interasse 105  
 centre 105

# sistema di montaggio maniglioni

*pulls mounting system*

## PASSANTE ACCOPPIATO BACK TO BACK FIXING

### KBY16-KBY26 *byblos*

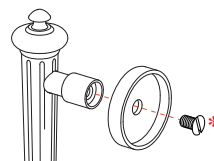
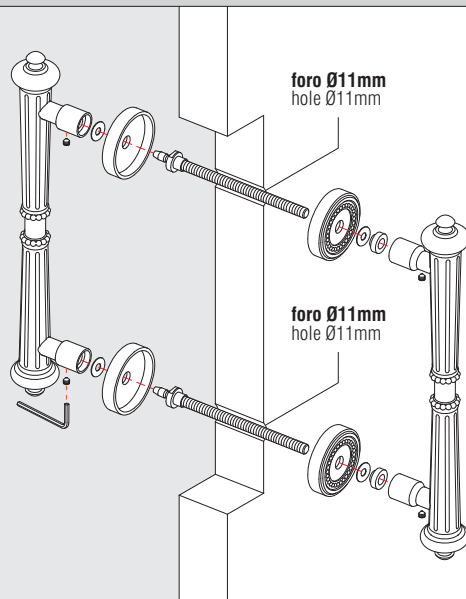

**Sostituire le viti premontate\* sotto le rosette del KBY16/26 e utilizzare le barre filettate M8 per l'accoppiamento con il KBY16/26**

Replace the pre-mounted screws under the KBY16/26 rose and use the M8 threaded bars for the KBY16PA/26PA back to back fixing

**i** KBY16 - interasse 220  
KBY16 - centre 220

**i** KBY26 - interasse 300  
KBY26 - centre 300

### KIM16PA-KIM26PA *impero*

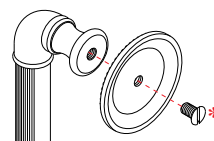
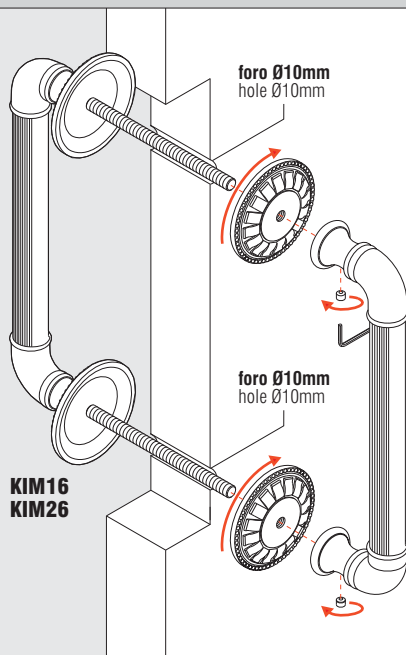

**Sostituire le viti premontate\* sotto le rosette del KIM16/26 e utilizzare le barre filettate M8 per l'accoppiamento con il KIM16PA/26PA**





Replace the pre-mounted screws under the KIM16/26 rose and use the M8 threaded bars for the KIM16PA/26PA back to back fixing

**i** interasse 248  
centre 248

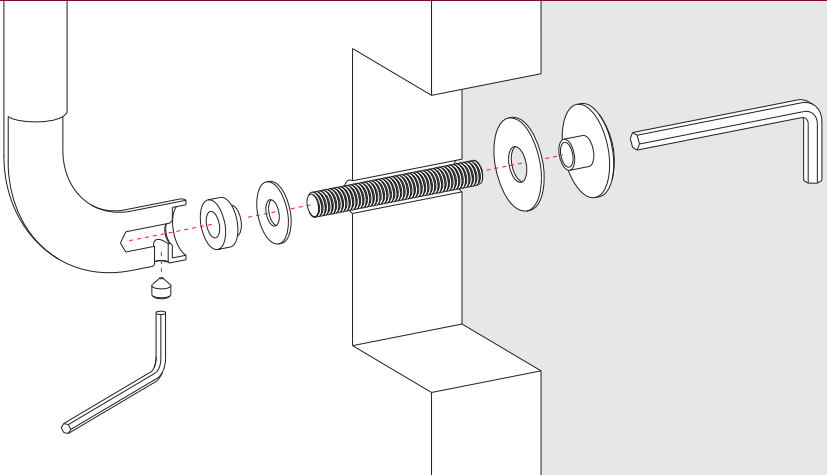
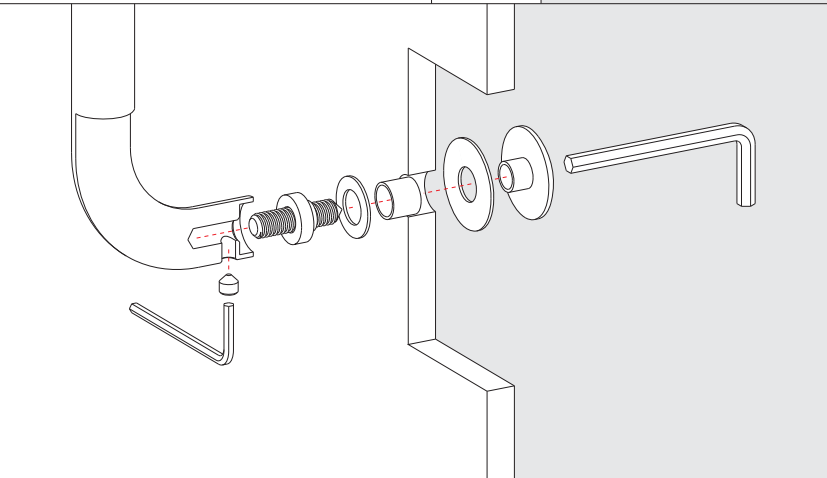

# kit di fissaggio per maniglioni senza rosette

fixing kits for pulls without roses

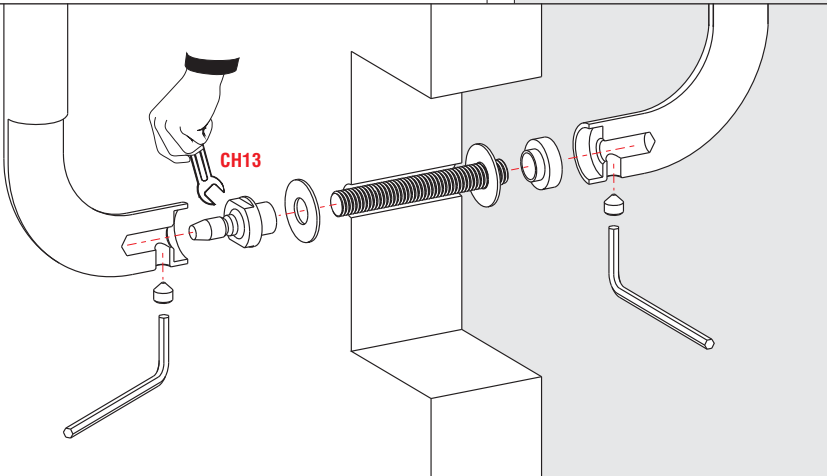
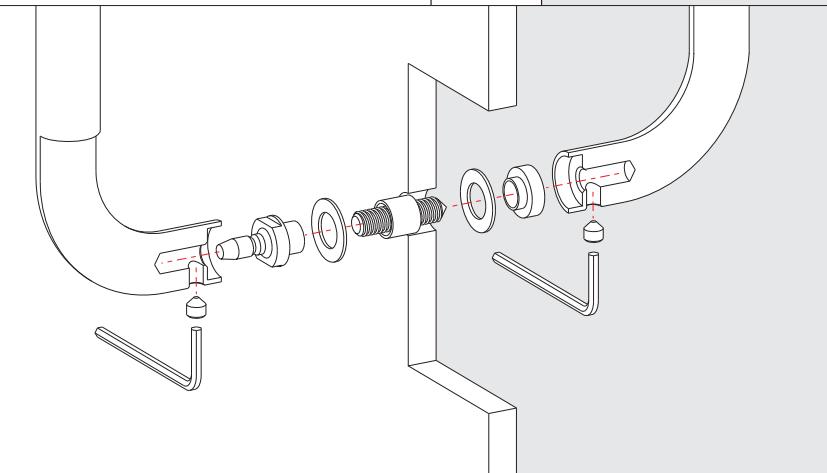
KIT DI FISSAGGIO FIXING KIT	TIPOLOGIA TYPOLOGY	ART.	ESPLOSO TECNICO TECHNICAL DETAILS
 <p><b>KIT PS</b> Passante Singolo Single pull-bolt through</p> <p>acciaio-ottone steel-brass</p> 	<p><b>SP</b> 10 ÷ 80mm</p> <p><b>FORO HOLE</b> Ø11mm</p> <p><b>LEGNO</b> wood doors</p> <p><b>ALLUMINIO</b> aluminium doors</p> <p><b>PVC</b> pvc doors</p> <p><b>BLINDATE</b> armoured doors</p>	<p>barocco byblos capri venezia</p>	
	<p><b>SP</b> &gt; 10mm</p> <p><b>FORO HOLE</b> Ø13mm</p> <p><b>VETRO</b> glass doors</p>	<p>barocco byblos capri venezia</p>	
 <p><b>KIT PA</b> Passante Accoppiato Back to back fixing</p> <p>acciaio steel</p> 	<p><b>SP</b> 10 ÷ 80mm</p> <p><b>FORO HOLE</b> Ø11mm</p> <p><b>LEGNO</b> wood doors</p> <p><b>ALLUMINIO</b> aluminium doors</p> <p><b>PVC</b> pvc doors</p> <p><b>BLINDATE</b> armoured doors</p>	<p>barocco byblos capri venezia</p>	
	<p><b>SP</b> &gt; 10mm</p> <p><b>FORO HOLE</b> Ø13mm</p> <p><b>VETRO</b> glass doors</p>	<p>barocco byblos capri venezia</p>	

# sistemi di montaggio maniglioni per alzante scorrevole

mounting system for pull-up handles for sliding door

KBU113 - KIM113 - KLU113

busiri - impero - louis XVI

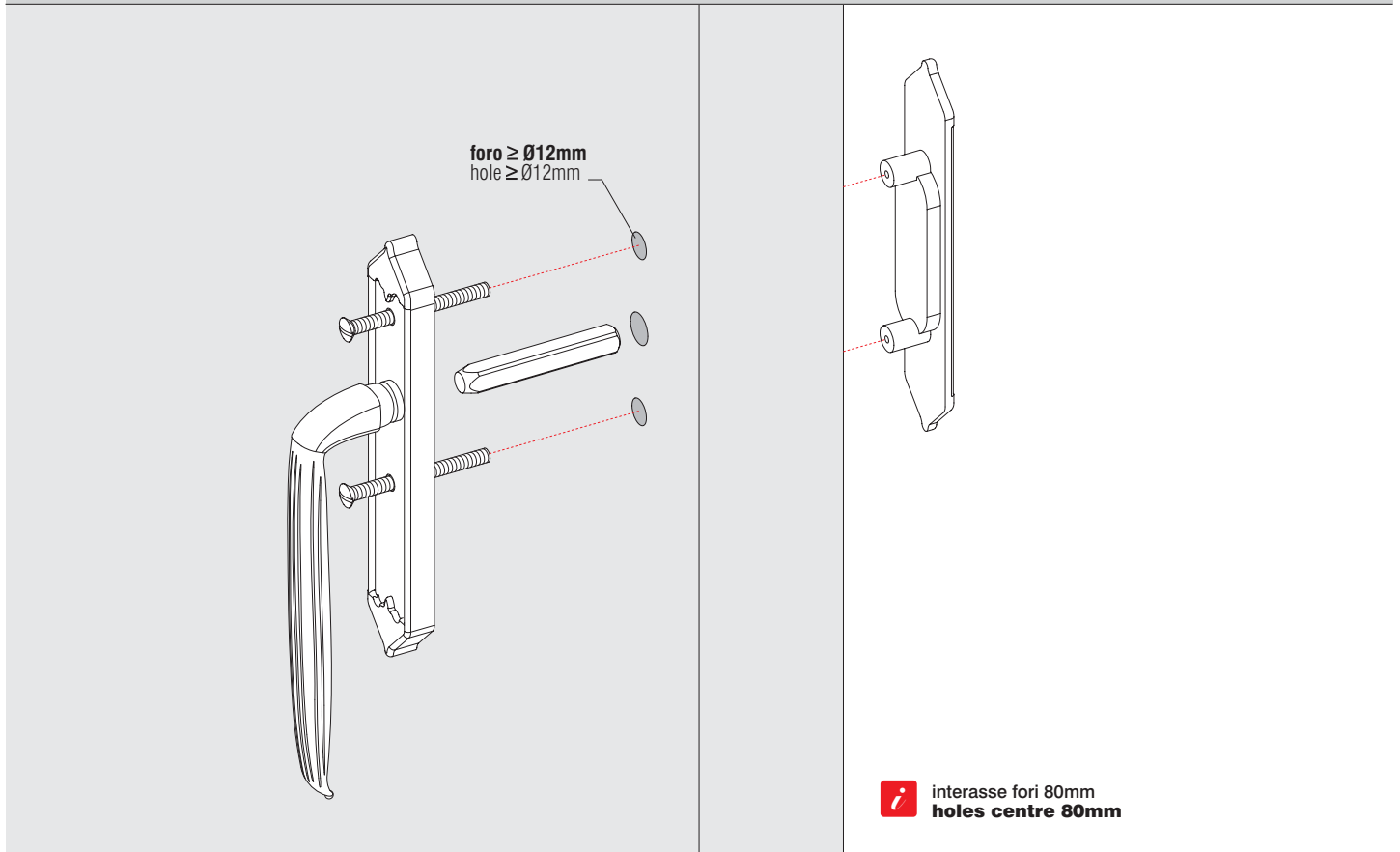

# sistema di montaggio battiporta

door knockers mounting system

**KOT115**  
PASSANTE SINGOLO BOLT THROUGH FIXING

ottocento

**KOT215**  
PASSANTE SINGOLO BOLT THROUGH FIXING

ottocento

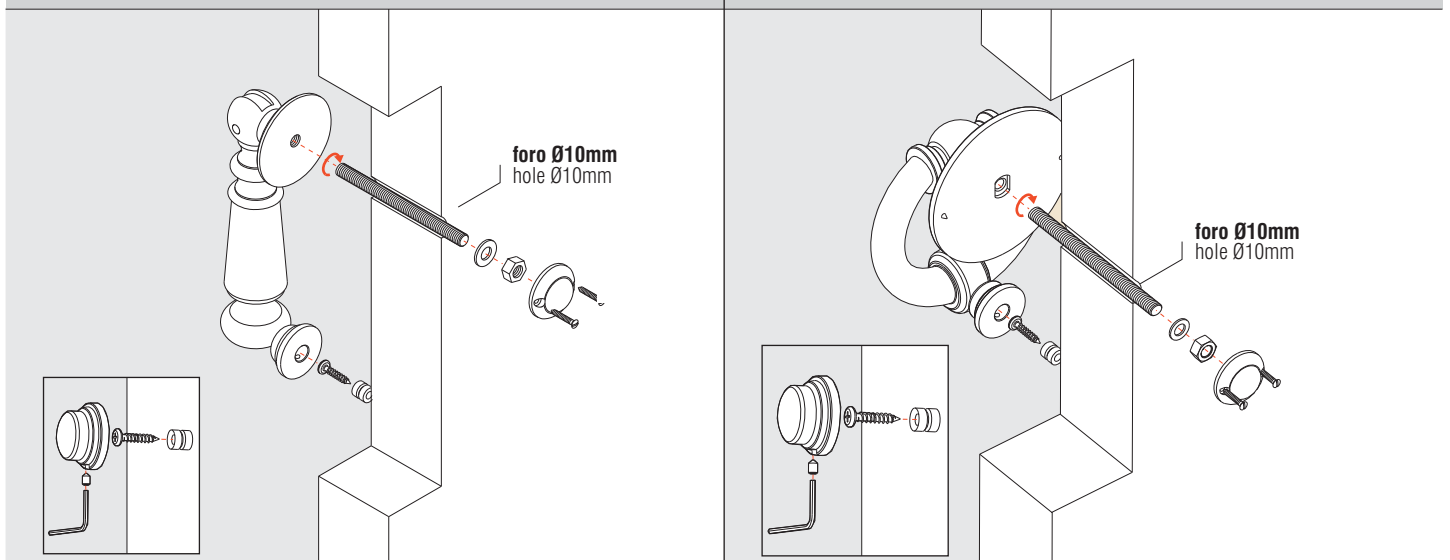

# dimensioni fresata maniglie incasso

milling sizes of flush handles

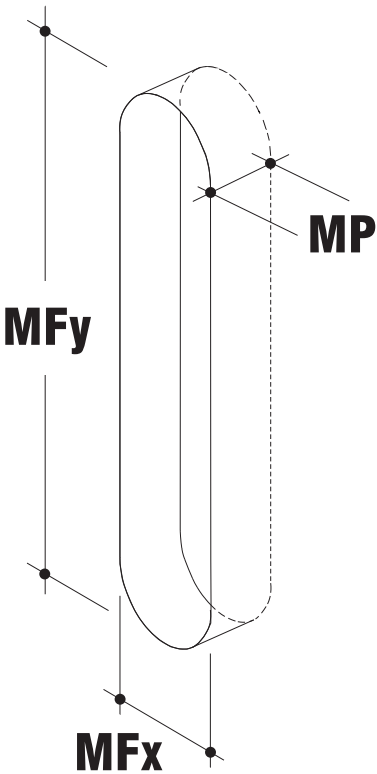
DIMENSIONI SIZES	MANIGLIE HANDLES	ARTICOLO ARTICLE	MFx	MFy	MP	MATERIALE MATERIAL
	<i>busiri</i>	<b>KBU111</b>	<b>27</b>	<b>100</b>	<b>9</b>	<b>OTTONE . BRASS</b>
		<b>KBU111CF</b>				
	<i>louis XVI</i>	<b>KLU111</b>	<b>28</b>	<b>80</b>	<b>9</b>	<b>OTTONE . BRASS</b>
		<b>KLU111CF</b>				
<i>ottocento</i>	<b>KOT111</b>	<b>28</b>	<b>108</b>	<b>14</b>	<b>OTTONE . BRASS</b>	
	<b>KOT111CF</b>					
<p><b>i MFx</b> misura larghezza fresata milling width size</p> <p><b>i MFy</b> misura altezza fresata milling height size</p> <p><b>i MP</b> misura profondità fresata milling internal depth size</p> <p><b>i</b> le misure riportate sono indicative ed espresse in millimetri the measures mentioned are indicatif and herein are stated in millimetres</p> <p><i>dimensioni fresata maniglie incasso per maniglioni per alzante scorrevoli</i> milling sizes of flush handles for pull-up handles for sliding door</p>						
<i>busiri</i>	<b>KBU113</b>	<b>32</b>	<b>92</b>	<b>14</b>	<b>OTTONE . BRASS</b>	
<i>impero louis XVI</i>	<b>KIM113 KLU113</b>	<b>28</b>	<b>94</b>	<b>17</b>	<b>OTTONE . BRASS</b>	

## fissaggio maniglie incasso Busiri (KBU111) e Ottocento (KOT111)

Busiri (KBU111) and Ottocento (KOT111) flush handles fixing

**i** chiodini non compresi nella confezione  
the nails are not included

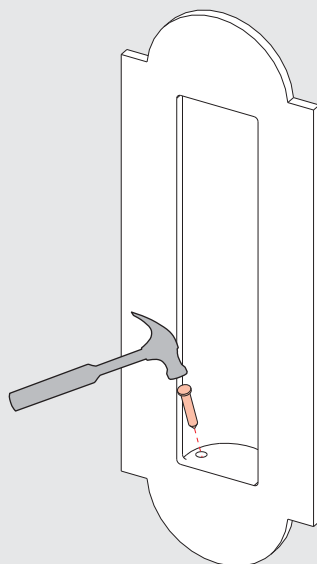

# sistemi di montaggio cremonese per aste esterne

mounting system for window handle for external rods

KOT22AV

ottocento

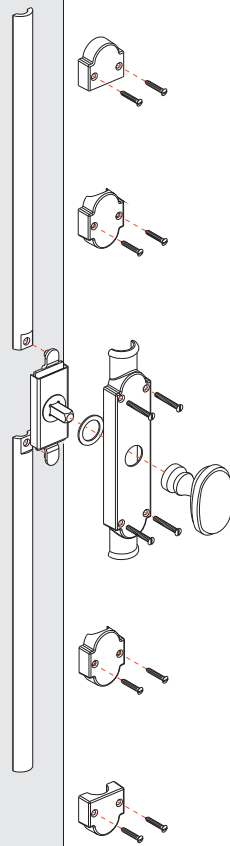

# sistemi di montaggio buca per lettere

letter plate mounting system

KOT218  
PASSANTE SINGOLO BOLT THROUGH FIXING

ottocento

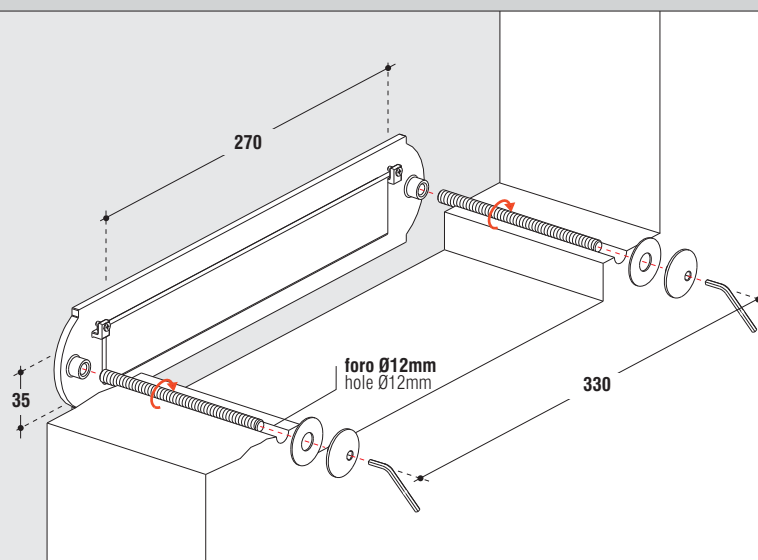

*Indice dei codici*  
*Code index*

# indice dei codici

code index

ARTICOLO ARTICLE	PAGINA PAGE	ARTICOLO ARTICLE	PAGINA PAGE	ARTICOLO ARTICLE	PAGINA PAGE
KAC11 PB70 I 70	16	KBE11 RB 36x50	24	KBY11 RY Ø55	32
KAC11 PB90 I 90	16	KBE11 RBY 36x50	24	KBY112	124
KAC11 PBY85 I 85	16	KBE12	24	KBY12	32
KAC11 R Ø45	16	KBE12 B	24	KBY12 CRDK	32
KAC11 RB Ø45	16	KBE12 DK/SM	24	KBY12 DK/SM	32
KAC11 RBO 28x61	16	KBE13 BP 36x50	24	KBY13 P Ø55	32
KAC11 RBOY 28x61	16	KBE13 BY (Y) 36x50	24	KBY13 Y (Y) Ø55	32
KAC11 RBY Ø45	16	KBU11 P70 I 70	28	KBY15 FISSO Ø120	88
KAC11 RY Ø45	16	KBU11 P90 I 90	28	KBY16	96
KAC119 25x37	90	KBU11 PY85 I 85	28	KBY16NP	96
KAC12	16	KBU11 R 39,5x48,5	28	KBY19 BZG 6B Ø55	32-80
KAC12 B	16	KBU11 RY 39,5x48,5	28	KBY25 FISSO Ø120	88
KAC12 CRDK	16	KBU111	110	KBY26	96
KAC12 DK/SM	16	KBU111CF	110	KBY26NP	96
KAC13 BP Ø45	16-36-84	KBU113	104	KCHIAVE2	130
KAC13 BY (Y) Ø45	16-36-84	KBU119/A 28x30	90	KCHIAVE2,5	130
KAC15 R Ø45	84	KBU119/B 25x22	90	KCHIAVE3	130
KAC15 RB Ø45	84	KBU119/C 16x14	90	KCR11 RB Ø45	36
KAC15 RBY Ø45	84	KBU12	28	KCR11 RBY Ø45	36
KAC15 RY Ø45	84	KBU12 B	28	KCR119 Ø21	90
KAC19 BZG 6B Ø45	16-80	KBU12 DK/SM	28	KCR12	36
KBA11 P70 I 70	20	KBU13 BP 39,5x48,5	28-84	KCR12 B	36
KBA11 P90 I 90	20	KBU13 BY (Y) 39,5x48,5	28-84	KCR12 CRDK	36
KBA11 PY85 I 85	20	KBU14	118	KCR12 DK/SM	36
KBA11 R Ø50	20	KBU15 R 39,5x60	84	KCR16	98
KBA11 RY Ø50	20	KBU15 RY 39,5x60	84	KCR19 BZG 6B Ø45	36-80
KBA12	20	KBU16	94	KCR26	98
KBA12 CRDK	20	KBU19 BZG 6B 36,5x48,5	24-28-80	KDADO	124
KBA12 DK/SM	20	KBU25 FISSO 70x70	88	KDK	129
KBA13 P Ø50	20	KBU26NP	94	KDK-40	129
KBA13 Y (Y) Ø50	20	KBU26PS	94	KDK40D	129
KBA16	94	KBU35 FISSO 110x110	88	KDO 15 FISSO Ø119,5	88
KBA19 BZG 6G Ø50	20-80	KBY11 P70 I 70	32	KDUMMY	129
KBE11 PB70 I 70	24	KBY11 P90 I 90	32	KESP.BANCO	132
KBE11 PB90 I 90	24	KBY11 PY85 I 85	32	KESP/BSB	132
KBE11 PBY85 I 85	24	KBY11 R Ø55	32	KESP/BSP	132

ARTICOLO ARTICLE	PAGINA PAGE	ARTICOLO ARTICLE	PAGINA PAGE	ARTICOLO ARTICLE	PAGINA PAGE
KGRANO4X6	130	KLU11 RBY Ø50	52	KMP-7	128
KGRANO5X6	130	KLU11 R Ø45	52	KMP/AV	128
KGRANO6X6	130	KLU11 RY Ø50	52	KOT11 PB70 I 70	56
KGRATZ	128	KLU111	110	KOT11 PB90 I 90	56
KGRATZ-7	128	KLU111CF	110	KOT11 PBY85 I 85	56
KGRATZ-7CB	128	KLU113	104	KOT11 R Ø45	56
KGRATZ-7CP	128	KLU119 19,5x45,5	90	KOT11 RB Ø45	56
KGRATZ-CB	128	KLU12	52	KOT11 RBO 28x61	56
KGRATZ-CP	128	KLU12 B	52	KOT11 RBOY 28x61	56
KGUERRIERO	128	KLU12 CRDK	52	KOT11 RBY Ø45	56
KIM11 PB70 I 70	44	KLU12 DK/SM	52	KOT11 RY Ø45	56
KIM11 PB90 I 90	44	KLU13 BP Ø45	44-52-64-84-86	KOT111	112
KIM11 PBY85 I 85	44	KLU13 BY (Y) Ø50	44-52-64-84-86	KOT111CF	112
KIM11 R Ø45	44	KLU14	118	KOT115	106
KIM11 RB Ø45	44	KLU15 R Ø45	84	KOT118	120
KIM11 RBO 28x61	44	KLU15 RB Ø45	84	KOT12	56
KIM11 RBOY 28x61	44	KLU15 RBY Ø45	84	KOT12 B	56
KIM11 RBY Ø50	44	KLU15 RY Ø45	84	KOT12 CRDK	56
KIM11 RY Ø50	44	KLU16NP	100	KOT12 DK/SM	56
KIM113	104	KLU16PS	100	KOT13 BP Ø45	40-56-60-68 72-76-86
KIM119 Ø26,5	90	KLU18/A L.L	122	KOT13 BY (Y) Ø45	40-56-60-68 72-76-86
KIM12	44	KLU18/A M.TT	122	KOT15 R Ø45	86
KIM12 B	44	KLU18/A MAGIC	122	KOT15 RB Ø45	86
KIM12 CRDK	44	KLU18/A V.I	122	KOT15 RBY Ø45	86
KIM12 DK/SM	44	KLU18/B MAGIC	122	KOT15 RY Ø45	86
KIM14	118	KLU18/C MAGIC	122	KOT16	102
KIM16	98	KLU19 BZG 6B Ø45	52 - 80	KOT18/A L.L	122
KIM19 BZG 6B Ø45	44-80	KLU23 BP Ø45	86	KOT18/A M.TT	122
KIM24	118	KLU23 BY (Y) Ø50	86	KOT18/A MAGIC	122
KIM26	98	KLU25 RB 50x34	86	KOT18/A V.I	122
KITPA	94-96-98-102	KLU25 RBY 50x34	86	KOT18/B MAGIC	122
KITPS	94-96-98-102	KLU26NP	100	KOT18/C MAGIC	122
KLU11 PB70 I 70	52	KLU26PS	100	KOT19 BZG 6B Ø45	40-48-56-60 68-76-80
KLU11 PB90 I 90	52	KMOLLA	130	KOT21 PB70 I 70	40
KLU11 PBY85 I 85	52	KMOLLA P	130	KOT21 PB90 I 90	40
KLU11 RB Ø45	52	KMP	128	KOT21 PBY85 I 85	40

# indice dei codici

code index

ARTICOLO	ARTICLE	PAGINA	PAGE	ARTICOLO	ARTICLE	PAGINA	PAGE	ARTICOLO	ARTICLE	PAGINA	PAGE
KOT21	RB Ø45	40		KPA11	RBV Ø45	60		KSE21	RB Ø45	64	
KOT21	RBO 28x61	40		KPA11	RY Ø45	60		KSE21	RBO 28x61	64	
KOT21	RBOY 28x61	40		KPA12		60		KSE21	RBOY 28x61	64	
KOT21	RBV Ø45	40		KPA12	B	60		KSE21	RBV Ø50	64	
KOT215		106		KPA12	DK/SM	60		KSE21	RY Ø50	64	
KOT218		120		KPA22		60		KSE22		64	
KOT22	B	40		KPA22	B	60		KSE22	B	64	
KOT22	CRDK	40		KPANNELLO6		132		KSE22	CRDK	64	
KOT22	DK/SM	40		KPANNELLO9		132		KSE22	DK/SM	64	
KOT22A0160		116		KQUADRO80		129		KSI11	PB70 I 70	72	
KOT22A0250		116		KQUADRO90		129		KSI11	PB90 I 90	72	
KOT22AV		116		KQUADROBLK45		129		KSI11	PBY85 I 85	72	
KOT22PS		116		KQUADROBLK50		129		KSI11	R Ø45	72	
KOT22TO		116		KQUADROBLK55		129		KSI11	RB Ø45	72	
KOT23	P Ø45	48		KQUADROM7-65		129		KSI11	RBO 28x61	72	
KOT23	Y (Y) Ø45	48		KQUADROM7-70		129		KSI11	RBOY 28x61	72	
KOT26		102		KROSDK		124		KSI11	RBV Ø45	72	
KOT31	P70 I 70	48		KSE11	PB70 I 70	68		KSI11	RY Ø45	72	
KOT31	P90 I 90	48		KSE11	PB90 I 90	68		KSI12		72	
KOT31	PY85 I 85	48		KSE11	PBY85 I 85	68		KSI12	B	72	
KOT31	R Ø45	48		KSE11	R Ø45	68		KSI12	DK/SM	72	
KOT31	RBO 28x61	48		KSE11	RB Ø45	68		KSI19	BZG 6B Ø45	72-80	
KOT31	RBOY 28x61	48		KSE11	RBV Ø50	64		KUN112		124	
KOT31	RY Ø45	48		KSE11	RY Ø50	64		KVE11	RB Ø45	76	
KOT318		120		KSE119	Ø26,5	90		KVE11	RBV Ø45	76	
KOT32		48		KSE12		68		KVE12		76	
KOT32	DK/SM	48		KSE12	B	68		KVE12	B	76	
KOT36		102		KSE12	DK/SM	68		KVE12	CRDK	76	
KOT418		120		KSE14		118		KVE12	DK/SM	76	
KPA11	PB70 I 70	60		KSE15	RB Ø45	86		KVE16		102	
KPA11	PB90 I 90	60		KSE15	RBV Ø50	86		KVE26		102	
KPA11	PBY85 I 85	60		KSE19	BZG 6B Ø45	64-80		KVITE3.5		130	
KPA11	R Ø45	60		KSE21	PB70 I 70	64		KVITE3X16	KVITE3X20	130	
KPA11	RB Ø45	60		KSE21	PB90 I 90	64		KVITE3X25	KVITE3X30	130	
KPA11	RBO 28x61	60		KSE21	PBY85 I 85	64		KVITE4X30		130	
KPA11	RBOY 28x61	60		KSE21	R Ø45	64					







***Lo sviluppo è sostenibile se soddisfa i bisogni delle generazioni presenti senza compromettere le possibilità per le generazioni future di soddisfare i propri bisogni.***

*Sustainable development is development that meets the needs of the present without compromising the ability of future generations to meet their own needs.*

*(Brundtland Report, United Nations, 1987)*

**E' tempo di Green Made.**

Green Made significa pensare, progettare e produrre in armonia con l'ambiente.

**It's Green Made time.**

Green made means thinking, developing and manufacturing in harmony with our environment.

*Data l'artigianalità del prodotto le misure sono indicative ed espresse, se non diversamente specificato, in millimetri.*

*Colombo Design si riserva di apportare ai propri prodotti ogni modifica estetica e tecnica che a suo insindacabile giudizio ritenga necessaria.*

*Il presente catalistino è tutelato dalla legge sui diritti di autore di esso è quindi proibita ogni riproduzione, totale o anche parziale. Le textures ed i colori dei materiali e delle finiture hanno valore indicativo in quanto soggetti alle tolleranze dei processi di stampa.*

*Because of the craftsmanship of the product, all measures mentioned are indicatif and herein are stated in millimetres, if not specified in a different way.*

*Colombo Design reserves the right to modify parts of it's collection range whenever if necessary without previous notice to the customer.*

*This catalogue/price list is protected by the Italian copyright law and by law all right are reserved. No part of this catalogue may be reproduced in any form or by any means.*

*The textures and colours of materials and finishes are not binding as they depend on printing colour tolerances.*

**Catalistino**

Price List

03/2022

**Marzo**

March

2022

**Versione**

Release

R1-0322

**Codice di produzione**

Production Code

ZCATALIST.A 03/22

**[www.colombodesign.it](http://www.colombodesign.it)**

**[info@colombodesign.it](mailto:info@colombodesign.it)**

COLOMBODESIGN.IT



*Trademark of:*

